

# Installation and Operating Handbook

## PTR50 Series Beacon Tracking Receiver

Covers software version 2.00 and above

Handbook Issue 2.02, 30/08/2023



PEAK COMMUNICATIONS Ltd.  
Unit 1, The Woodvale Centre, Woodvale Road,  
Brighouse, West Yorkshire  
HD6 4AB, England

Phone +44 (0)1484 714200  
Fax +44 (0)1484 723666



**IMPORTANT NOTE: THE INFORMATION AND SPECIFICATIONS  
CONTAINED IN THESE DOCUMENTS SUPERSEDE ALL PREVIOUSLY  
PUBLISHED INFORMATION CONCERNING THESE PRODUCTS**

# Table of Contents

<b>CUSTOMER CARE</b> .....	4
<b>PRODUCT COMPLIANCE</b> .....	5
<b>Safety</b> .....	5
<b>EMC</b> .....	5
<b>1. INTRODUCTION</b> .....	6
<b>1.1</b> General product overview & principles of operation .....	6
<b>1.2</b> Functional description .....	6
<b>1.3</b> PTR50 Specifications .....	7
<b>1.4</b> Input Section.....	10
<b>1.4.1 Internal Beacon Receiver DownConverter section</b> .....	12
1.4.1.1 DownConverter Input .....	12
1.4.1.2 DownConverter resolution .....	12
1.4.1.3 DownConverter Conversion Gain.....	12
1.4.1.4 Auxiliary DC and 22KHz tone .....	12
1.4.1.5 10MHz reference output.....	12
<b>1.4.2 Internal Beacon Receiver Tracking Section</b> .....	12
1.4.2.1 Tracking Output .....	12
1.4.2.2 Tracking Level .....	12
1.4.2.3 Sweep Range .....	12
1.4.2.4 Sweep Rate .....	13
1.4.2.5 Post Detection Time Constant.....	13
1.4.2.6 Log Output Scale.....	13
1.4.2.7 DC Output Adjustment .....	13
1.4.2.8 PLL Noise Bandwidth .....	13
1.4.2.9 Threshold for Reacquisition.....	13
1.4.2.10 ASB Sweep Rate.....	13
1.4.2.11 ASB Threshold .....	13
<b>1.4.3 Internal Beacon Receiver Video Section</b> .....	13
1.4.3.1 Video Input .....	13
1.4.3.2 Video Resolution .....	13
1.4.3.3 Vertical Resolution .....	13
1.4.3.4 Video Section Attenuator.....	13
1.4.3.5 Reference frequency .....	14
<b>1.5</b> Front panel description .....	15
<b>1.6</b> Rear panel description.....	15
1.6.1 Chassis Earth stud.....	15
1.6.2 Rx In .....	16
1.6.3 Rx Out .....	16
1.6.4 Ext Ref. ....	16
1.6.5 Alarms connector .....	16
1.6.6 RS232/RS485 Remote Control connector.....	16
1.6.7 Redundancy .....	17
1.6.8 Ethernet connector.....	17
<b>1.7</b> Fault philosophy.....	17
<b>2. INSTALLATION</b> .....	19
<b>2.1</b> Care of Your Product.....	19
2.1.1 Handling .....	19
2.1.2 Unpacking and Inspection.....	19
2.1.3 Storage.....	19
2.1.4 Cleaning & Maintenance.....	20
<b>2.2</b> Mechanical Installation Considerations .....	20
2.2.1 Mounting .....	20
2.2.2 Cooling .....	20
<b>2.3</b> Prime Power Supply & Connection .....	21
2.3.1 Fuses .....	21
2.3.2 Earthing.....	22
<b>2.4</b> Other Interface Connections.....	22

2.4.1 Internal Beacon Receiver L-band Connection .....	22
2.4.2 Internal Beacon Receiver SHF Connection .....	22
2.4.3 Internal Beacon Receiver Auxiliary Output Connection .....	22
2.4.5 External Reference Input Connection Option .....	23
2.4.7 Alarms Interface Connection .....	23
2.4.8 Remote Serial Communications Interface (RS-232/RS-485) .....	23
2.4.9 Redundancy Interface Connector .....	24
<b>3.0 EQUIPMENT OPERATION</b> .....	<b>25</b>
<b>3.1 Home menu</b> .....	<b>26</b>
3.1.1 Operating displays .....	26
3.1.1.2 Rx Level Display Screens .....	26
3.1.1.2a Beacon Receiver .....	26
3.1.1.3 Beacon Video Display Screen .....	26
3.1.2 Status screen .....	28
3.1.3 Configuration screen .....	28
3.1.3.2a Tracking Configuration screen .....	28
3.1.3.2a.6 DC Output Limits .....	38
3.1.3.4 Pilot Configure .....	38
3.1.3.5 Remote Control .....	39
3.1.3.5.1 Set remote mode .....	39
3.1.3.5.2 Setup RS485 .....	39
3.1.3.5.3 Setup RS232 .....	39
3.1.3.5.4 Set Protocol .....	40
3.1.3.5.5 Ethernet (Optional) .....	40
3.1.3.6 Redundancy .....	41
3.1.3.6.1 Identifier .....	41
3.1.3.6.2 Change Over .....	41
3.1.3.6.3 List Units in System .....	41
3.1.4 Log .....	42
3.1.5 Service .....	42
3.1.5.1 Fan .....	42
3.1.5.2 Tracking Rx LUT .....	43
3.2 Setup .....	44
<b>4. REDUNDANCY</b> .....	<b>46</b>
4.1 1+1 Redundancy (switched) .....	46
<b>5. REMOTE CONTROL</b> .....	<b>48</b>
5.1 P7xxx Protocol .....	48
5.3 Ethernet remote control (Optional) .....	72
<b>APPENDIX 1 Terms and conditions of sale</b> .....	<b>74</b>

## CUSTOMER CARE

Contact the Peak Communications sales department for:

- ✚ Product operation, application support or training requests
- ✚ Information for returning or upgrading a product
- ✚ Comments or suggestions on any supplied literature

### Contact Information

Peak Communications Ltd  
Attention: Sales Department  
Unit 1, The Woodvale Centre,  
Woodvale Road,  
Brighouse  
West Yorkshire  
HD6 4AB  
England  
Tel. +44 (0) 1484 714200  
Fax +44 (0) 1484 723666  
E-mail [Sales@peakcom.co.uk](mailto:Sales@peakcom.co.uk)

You can also contact us via our website at [www.peakcom.co.uk](http://www.peakcom.co.uk)

To return a Peak Communications product for repair:

1. Contact the Peak Communications sales department and request a Return Material Authorisation (RMA) number.
2. You will be required to provide to our sales representative the model number, serial number and a detailed description of the problem.
3. To prevent any damage to the product during shipment we recommend that the unit is returned in its original packaging or if this is not available the packaging used must be of an equal standard.
4. Return the product back to Peak Communications and advise shipment details to sales representative for tracking purposes. (Any shipping charges should be prepaid)

For information regarding our warranty policy see Appendix 1 Terms and conditions of sale.

## **PRODUCT COMPLIANCE**

### **Safety**

To ensure safety of operator the PTR50 series of Control Units have been designed to comply with the following safety standard;

EN 60950: Safety of information technology equipment, including electrical business machines.

Operation of the equipment in a non-standard manner will invalidate compliance to this standard.

The equipment **MUST BE OPERATED WITH ITS LID ON AT ALL TIMES**. If it is necessary to remove the lid for any purpose then it is essential that the lid is fitted back correctly before normal operation.

**DANGEROUS VOLTAGES ARE PRESENT AROUND THE POWER SUPPLY AND PRECAUTIONS MUST BE TAKEN.**

### **EMC**

The PTR50 series of Control Units have been designed to comply with the following standards;

Emissions: EN 55022 Class B; Limits and methods of measurement of radio interference characteristics of Information Technology Equipment.

Immunity EN 50082 Part 1; Generic immunity standard, part 1: Domestic, commercial and light industrial environment.

Damage to the keyboard membrane or mechanical damage to the chassis will also invalidate compliance; please contact the factory under these circumstances for advice on continued operation.

Interfaces to the PTR50 Series of Control Units must be made with suitably screened connectors and double screened coaxial cable. Data cables must be double screened.

All 'D' type connectors must have grounding fingers on the plug shell to guarantee continuous shielding. The back-shells must comply to the requirements of VDE 0871 and FCC 20708, providing at least 40 dB of attenuation from 30 MHz to 1 GHz.

Installations which do not comply with this requirement will invalidate the EMC specifications.

## 1. INTRODUCTION

### 1.1 General product overview & principles of operation



**Fig. 1 - PTR50 L-band Beacon Tracking Receiver**

This Manual covers the installation and operation of the PTR50 family of Beacon Tracking Receiver units. A specification for the PTR50 series Beacon Tracking Receiver is incorporated in this manual but is not guaranteed to be the latest, so please visit our website [www.peakcom.co.uk](http://www.peakcom.co.uk) for up to date specifications.

### 1.2 Functional description

The PTR50 will down convert an L-Band (SHF input options are available with the addition of a Block Down Converter before the L-band input) signal to an IF of  $70 \pm 18\text{MHz}$ , the signal is then split between the tracking function and the video display function, The tracking function then uses a coherent detector to lock to the CW beacon and measure the power of the beacon signal. The video function uses a detector to display the IF band on the front panel display allowing a required signal to be monitored. The unit also incorporates a switchable, triple sweep digital anti sideband detector to prevent the unit locking to beacon sidebands (the video function is only available when the ASB function has finished). The unit features a large graphic LCD display, membrane keyboard and menu driven software for control and configuration of the unit. The units have built in 1+1 redundancy control and can be remotely controlled via a RS232/485 port.

The PTR is fully software controlled; there are no links or switches used to configure the unit. This enables all control and configuration to be programmed either locally or by remote control. All the configuration parameters are stored in non-volatile memory that will retain data for a minimum of 5 years with no power applied.

Operating suggestions;

The following are suggested set points to enable the customer to get the best use out of the unit with the minimal of time.

Tracking sweep range of  $\pm 50\text{kHz}$ .

Sweep time of  $5\text{kHz/s}$ .

Log output of  $2\text{dB/V}$ .

The Coherent detector operates ideally with a post DownConverter level of between  $-60\text{dBm}$  to  $-90\text{dBm}$ , so by using the variable gain of the DownConverter section the optimum level can be achieved i.e. with an expected signal of  $-100\text{dBm}$  the DownConverter should be set towards its maximum gain of  $20\text{dB}$  and with an expected signal of  $-70\text{dBm}$  the gain should be set towards the minimum of  $0\text{dBm}$ .

When the expected signal exceeds  $-80\text{dBm}$  then it is suggested that the optional video  $10\text{dB}$  pad is turned on, to prevent compression of the video section (this does not affect the tracking section).

The ASB function is active for three sweeps when the unit has first locked, the down converted spectrum is swept and monitored for a higher signal and if one is found then the main receiver is forced to check the rest of the spectrum. This results in the unit locking to the highest-level signal in its sweep range. Due to the digital analysis of the bandwidth the ASB will take around 3 minutes to complete a full sweep. It is suggested that when the unit is used on a non-sideband beacon the ASB function should remain off.

### 1.3 PTR50 Specifications

This specification is provided to show typical values and explain the parameters involved. The specification may change so please refer to our website [www.peakcom.co.uk](http://www.peakcom.co.uk) for the latest up to date specifications.

#### ***PTR50 – Typical Specification***

##### **L-Band Input**

Option 12; Dual polarisation inputs, with local & remote user selection

Frequency range 925-2150MHz

Option 1f 2165MHz to 3835MHz

Note; wider L-Band & S-Band ranges available (please contact factory).

Connector N-type (f),  $50\Omega$

Option 4; F-Type (f),  $75\Omega$

Option 4b; BNC (f),  $75\Omega$

Option 4c; BNC (f),  $50\Omega$

Input return loss 15dB typical

Beacon input level  $-70\text{dBm}$  nom.,  $-50\text{dBm}$  max.

Aggregate input level  $-20\text{dBm}$  max.

User input level control; 0-30dB range, 0.5dB step attenuator, to increase the above composite L-Band input levels.

##### **SHF-Band Input (option 1)**

Input frequency options;

Option 1a; C-Band; 3.4-4.2GHz

Option 1b; X-Band; 7.25-7.75GHz

Option 1d; Full Ku-Band; 10.7-12.75GHz (unreferenced LNB)

Option 1e; Ka-Band (consult factory for band availability).

Beacon input level -90dBm nom., -70dBm max.

Aggregate input level -40dBm max.

Option 16; 0-30dB range, 0.5dB step attenuator, to increase the above composite SHF input levels.

### **DC Output**

Voltage range  $\pm 10\text{VDC}$ ,  $\pm 5\text{VDC}$ , 0 to 10VDC, -10 to 0VDC, user selectable

Slope settings Logarithmic, 0.5, 1, 2, 5 & 10dB/V, user settable

Connector BNC (f)

Impedance  $0\Omega$  (ideal voltage source, maximum current 5mA)

Adjustment range Output adjustable to 0V for input level between -60 & -100dBm

### **Auxiliary Buffered DC Output (option 13)**

Connector BNC (f),  $0\Omega$  (ideal voltage source, 5mA max)

### **Transfer Characteristics**

Post-detection time const. 150mS

Step size 1kHz

Search range  $\pm 20$ ,  $\pm 50$ ,  $\pm 100$ ,  $\pm 200$  &  $\pm 500\text{kHz}$ , user selectable

Sweep rate 2.5 & 5kHz/s, user selectable

Option 11; 2.5, 5, 10, 20, 40, 80, 120 & 240kHz/s

Level thermal stability  $-0.04\text{dB}/^\circ\text{C}$

### **Tracking Parameters**

PLL noise (IF) bandwidth 2kHz, fixed

Threshold lock reacquisition. 35dBHz, for sweep rates  $\leq 10\text{kHz/s}$

Average search time 6s, for search range  $\pm 20\text{kHz}$  and sweep rate 5kHz/s (see application note AN0025)

Option 11;  $< 1\text{s}$ , for search ranges of  $\leq \pm 50\text{kHz}$  and sweep rates  $\geq 80\text{kHz/s}$

### **Video section display (Beacon frequency $\pm 25\text{MHz}$ max.)**

Resolution bandwidth 6kHz

Display Graphical

### **Block Down Converter/ LNB Drive**

Fed on L-Band input, user selectable (on/off);



Ext Ref; 10MHz (0dBm nom)  
Range select; 22kHz tone & DC voltage level (13-15/ 18-20VDC)  
Power; 500mA max. (300mA per output for option 12)

### **L-Band Monitor for SHF inputs (option 2)**

Connection BNC (f), 50Ω  
Level -20dBc ±3dB

### **Pilot 'CW' Generator Output (option 14)**

For 'self-test' & for use when satellite has no useable beacon signal

Frequency range 850-2,150MHz, user settable  
Connector SMA (f), 50Ω  
Level -50 to -80dBm  
Step size 125kHz

### **Internal Reference**

Frequency 10MHz  
Adjustment ±0.45ppm, stepped 0.01ppm  
Stability  
Allan deviation <math>5 \times 10^{-12}</math> over 1s  
Ageing <math>3 \times 10^{-10}</math> per day, <math>3 \times 10^{-8}</math> per year  
Temp stability <math>2 \times 10^{-9}</math> over -10 to 50°C

### **Mechanical**

Width 19", standard rack mount  
Height 1U (1.75")  
Depth 534mm (21"), plus connectors  
Construction Stainless steel chassis  
Weight Approx. 8kg (18lbs)

### **Environmental**

Operating temp 0° to +50°C  
EMC EN55022, part B & EN50082-1  
Safety EN60950

### **Power Supply**

Voltage 90-264VAC  
Frequency 47-63Hz  
Power 50 Watts max (configuration dependant)  
Option 10; Redundant PSU's with separate prime power inputs

### **Control System**

Remote control      RS232/RS485 port

Option 9;      Ethernet; embedded web server & SNMP network management support

#### Alarms

LO lock failure

PSU failure

External alarm inputs

Summary failure relay (form C)

Out of lock alarm (form C)

#### Options

- 1a) C-Band beacon input.
- 1b) X-Band beacon input.
- 1d) Full Ku-Band beacon input.
- 1e) Ka-Band beacon input.
- 2) L-Band monitor (for SHF input options).
- 4) F-Type, 75Ω, input connection
- 4b) BNC, 75Ω, input connection
- 4c) BNC, 50Ω, input connection
- 9) Ethernet interface with embedded web server & SNMP
- 10) Redundant power supplies
- 11) Fast lock acquisition to <1s
- 12) Dual polarisation inputs
- 13) Auxiliary buffered receiver DC output
- 14) Pilot 'CW' signal output
- 16) SHF input level control (only valid with option 1)

Note; the addition of options can modify the typical performance, for details please consult the factory

#### 1.4 Input Section

##### **Internal Beacon Receiver**

An internal Beacon Receiver accepts an L-Band (SHF input options are available) input signal via an N-Type (f), 50Ohm connection on the rear panel;

##### **Beacon Receiver input frequency and performance;**

The following Beacon input frequency ranges are available;

	L-Band (925-2150MHz) input
Return loss	15dB typical
Input Level;	-70dBm nom

-50dBm max  
-20dBm max aggregate power

A user adjustable L-Band composite input attenuator 0-30dB in 0.5dB steps is included. This will increase the nominal and maximum levels above when used.

Option 2a-2e                      -90dBm nom  
   -70dBm max  
   -40dBm max aggregate power

SHF composite input attenuators are available as an option  
This will increase the nominal and maximum levels above when used.

Slope                                      Logarithmic, 0.5dB/V, 2dB/V, 5dB/V & 10dB/V (user selectable from front panel menu)  
Output Connector                      BNC (f)  
**Transfer Characteristics;**  
Synthesizer step size                1Hz  
Search range                            ±20kHz, ±50kHz, ±100kHz, ±200kHz, ±500kHz, user selectable

**Tracking Parameters;**  
PLL noise (IF) BW                    2kHz fixed  
Threshold lock reacquisition       35dBHz  
Average search time                 3s (for bandwidth of 2kHz)  
**Beacon 'display';**                    Graphical  
Resolution Bandwidth                6kHz

**External reference input option;**  
An external reference input is available via a BNC (f), 50Ohm connect.  
Frequency                              Factory selectable 5 or 10MHz  
Level                                      0dBm, ±3dB  
Phase noise                            To be better than 50dBc/Hz of output Phase Noise

**Internal reference;**  
An internal back-up reference is provided that automatically takes over if the external reference is either not provided, is disconnected or fails.

Frequency                              10MHz  
Adjustment                             ±1.0ppm, stepped 0.02ppm  
Stability                                <5 x 10<sup>-10</sup> over 1s, <5 x 10<sup>-9</sup> per 12 hrs  
Ageing                                    <5 x 10<sup>-7</sup> per year  
Temperature stability                <5 x 10<sup>-8</sup> over 0 to 40°C

### **1.4.1 Internal Beacon Receiver DownConverter section**

#### **1.4.1.1 DownConverter Input**

925 MHz to 2150MHz full L-Band down conversion the selected frequency is passed to the Tracking section with a bandwidth of  $\pm 2.5$ MHz and to the Video section with  $\pm 25$ MHz

#### **1.4.1.2 DownConverter resolution**

1KHz Tracking frequency step size.

#### **1.4.1.3 DownConverter Conversion Gain**

Adjustable down conversion gain is available for best noise performance and dynamic range.

0 to 20dB  $\pm$  stepped 0.1dB

The gain of the converter can be set to have no gain at 0dB or a gain of 20dB. The finite gain set is specified to be within 2dB of the setting and the step size is 0.1dB. The tolerance of the step size is not specified but should not exceed 0.05dB per step.

#### **1.4.1.4 Auxiliary DC and 22KHz tone**

Selectable regulated voltage 13-15V in steps and 18 to 20V in steps @ 0.5 Amp, software switchable on / off

This facility is used for driving an external SHF block down converter or an LNB. This voltage is integrated with the L-Band signal (and 10MHz). The current is limited and protected.

~~The 22KHz tone function can be enabled and disabled via the front panel~~

#### **1.4.1.5 10MHz reference output**

0dBm nominal, software switchable

This facility is used for stabilising the output frequency of an external L-Band to SHF Block DownConverter. This signal is integrated with the L-Band output signal. An outdoor BDC/LNB will drift in frequency due to ambient temperature changes causing changes to the BDC locking crystal inside the unit. Inside Peak BDC's the facility is made to pick up the 10MHz locking signal sent by the PTR50 and lock to the internal crystal. With the BDC locked to the indoor unit the stability of the BDC unit is as good as the internal PTR50 crystal. With very long cables caution should be taken not to attenuate the 10MHz (and DC) too much.

### **1.4.2 Internal Beacon Receiver Tracking Section**

#### **1.4.2.1 Tracking Output**

DC voltage proportional to the received signal strength at the required dB/V and offset using the DC offset menu to between  $-10$ V to  $+10$ V DC

#### **1.4.2.2 Tracking Level**

Maximum Tracking signal level is  $-20$ dBm when input composite attenuator is at 30dB and downconverter gain is 0dB, the minimum is determined by the noise level on the carrier though the unit will become nonlinear below  $-110$ dBm at these levels the composite input attenuator shall be set to minimum and the downconverter gain to full.

#### **1.4.2.3 Sweep Range**

5 user selectable sweep widths to allow for drifts on the required signal whilst searching it is suggested to leave on the narrower settings as this will speed up

acquisition of lock. The settings available are  $\pm 20\text{kHz}$   $\pm 50\text{kHz}$   $\pm 100\text{kHz}$   $\pm 200\text{kHz}$   $\pm 500\text{kHz}$ . It is suggested to use the narrowest setting if possible. Use of non 10MHz referenced LNB's may require the use of a wider sweep width, to allow lock acquisition. To help acquire lock, every third sweep is  $\pm 100\text{kHz}$ .

#### 1.4.2.4 Sweep Rate

Up to 8 user selectable sweep rates allow the user the choice to speed up the acquisition of lock. The user must be aware that the lower the signal to noise ratio the slower the sweep rate needs to be to guarantee lock detection. The settings available are; 2.5KHz/s, 5KHz/s on standard units, on fast acquisition units the extra sweep rates are; 10KHz/s, 20KHz/s, 40KHz/s, 80KHz/s, 120KHz/s, 240KHz/s. It is suggested to use 5kHz/s as a starting point.

#### 1.4.2.5 Post Detection Time Constant

This is the smoothing on the DC output and is factory set to the value of 150ms.

#### 1.4.2.6 Log Output Scale

4 User selectable settings for the DC Logarithmic output voltage. The settings available are 0.5dB/V, 1dB/V, 2dB/V, 5dB/V & 10dB/V.

#### 1.4.2.7 DC Output Adjustment

User adjustable offset of the Log output adjustable to 0V DC for input power levels from  $-20\text{dBm}$  to  $-100\text{dBm}$  at 2dB/V.

#### 1.4.2.8 PLL Noise Bandwidth

This is factory set to 2kHz.

#### 1.4.2.9 Threshold for Reacquisition

A unit with option 11 unit will lock with a threshold of 43dB/Hz (unit must be on slowest sweep rate setting for these figures). A standard unit will acquire lock at 35dB/Hz at the slowest sweep speed.

#### 1.4.2.10 ASB Sweep Rate

The ASB when enabled will analyse the tracking band searching for a higher signal and if one is detected will enable the tracking lock circuit to release lock and search for this higher signal. The sweep rate on the ASB is around 80Hz/s.

#### 1.4.2.11 ASB Threshold

When the ASB is searching it is looking for a signal which is at least 3 dB higher than the current locked signal level

### 1.4.3 Internal Beacon Receiver Video Section

#### 1.4.3.1 Video Input

Selected Beacon frequency  $\pm 25\text{MHz}$  (lower limit of 925MHz upper limit 2150MHz) is available to display on the front panel. The minimum setting for span is set by the resolution i.e. with wide res the display can be 160 pixels of  $(6\text{kHz}/2) = 480\text{kHz}$  and with the narrow a minimum span of 80kHz is available.

#### 1.4.3.2 Video Resolution

The detector has a bandwidth of 6kHz

#### 1.4.3.3 Vertical Resolution

The display vertically axis is set to 10dB/division.

#### 1.4.3.4 Video Section Attenuator

It is Possible to switch in a 10dB pad to allow measurements to be better made if the unit has a high aggregate input level.

#### 1.4.3.5 Reference frequency

Internal 10MHz frequency, software trimmed.

Uses a high grade OCXO at 10MHz

External reference input: Will accept either 5 or 10MHz.

Stability;  $<5 \times 10^{-10}$  / second, ageing  $<5 \times 10^{-7}$  / year,  $<5 \times 10^{-9}$  / 24 hrs,  $<5 \times 10^{-8}$  over 0 to +50deg.C.

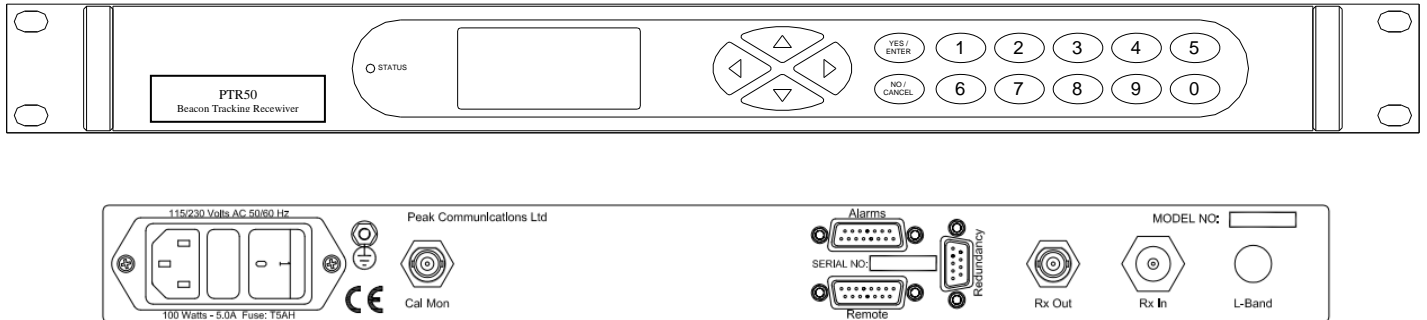

**Fig. 5 – front & rear panel views**

## 1.5 Front panel description

### Keyboard

The keyboard is of the membrane type and is an integral part of the front panel assembly. The front panel overlay and is completely sealed against penetration of liquids but caution should be taken especially with solvents which may damage the front screen.

There are 16 keys in total; number keys in the range 0 to 9, YES/ENTER and NO/CANCEL and a 4-way arrow block of keys

### LCD display

The backlit display is a graphic display and characters are scaled to incorporate as much information as possible on the screen. It provides detailed information about the status and configuration of the unit, and when appropriate, prompts the user to enter data via the keypad.

### LED Indicator

Only one tricolour LED is present marked STATUS. This shows GREEN when the unit is OK, RED when an internal fault is present and AMBER when in STANDBY (Redundancy operation)

## 1.6 Rear panel description

All of the connectors necessary for the user to interface the PTR50 series to other equipment are located at the rear of the unit. Depending on the model the connections may include the following;

Alarms, Remote Control, Redundancy; all 'D' type connections  
EC mains power connector/switch/fuse.

Beacon Receiver Output; labelled 'RX Out', always a BNC(f) connector.  
Beacon Receiver Input; labelled 'RX In', always an N-Type(f) connector.

The PTR50 series of converters are designed to operate from an AC mains supply, 90-264VAC, 47-63Hz. The Input connector incorporates a mains switch and 2 input fuses. Access to the fuses is also provided under the removable cover.

**ALWAYS REPLACE THE FUSE WITH ONE OF THE SAME TYPE AND RATING.**

### 1.6.1 Chassis Earth stud

To provide the correct level of safety to the operator this must be connected to a suitable safety earth provided in the rack installation. See the Safety and EMC comments in section 1.

### 1.6.2 Rx In

For the L-Band Beacon Receiver, the input frequency should be in the range 925 to 2150MHz or for units fitted with the optional SHF input (internal LNB), the frequency range will be as stated on the datasheet.

### 1.6.3 Rx Out

This is a 50Ohm, BNC (f) connector and it DC output to drive external equipment. CAUTION; DC is present on this connector at all times within the range of –10V to +10V.

### 1.6.4 Ext Ref.

Optionally fitted to the PTR50 series of converters this is the input for the 10MHz station clock input. The internal reference is 'locked' to the external reference. Connector type is 50Ohm SMA (f).

### 1.6.5 Alarms connector

This is a 15-pin male 'D' type connector, which provides access to the various form 'C' relay contacts which indicate alarm conditions.

### 1.6.6 RS232/RS485 Remote Control connector

This is a 15-pin female 'D' type connector. The PTR50 provides both an RS232 port for remote control, and an RS485 port for 'multi-drop' applications.



### 1.6.7 Redundancy

This is a 9-pin male 'D' type connector. The PTR50 has a built-in 1+1 redundancy controller. A pair of PTR50 units is required for correct operation plus a P1000 series switching unit.

### 1.6.8 Ethernet connector

This is an IEEE802.3 standard connector and is fitted to the rear panel if the Ethernet option is chosen at the time of order placement.

## 1.7 Fault philosophy

Fault conditions are divided into two categories;

- a) MAIN UNIT COMMON FAULTS; Faults with internal items that on a PTR50 are common to all sections of the unit (Main power supply assembly etc).
- b) DEVICE SPECIFIC FAULTS; Faults that are specific to the Tracking section or DownConverter or video assembly. These can include external fault inputs.

Most faults as shown below activate the summary ALARM; this will force a change-over if used in a normal redundant system.

The only fault that does not cause the unit to go into ALARM is the 'External Mute'. All faults shown below are reported on the front panel LCD and turn the tri-colour fault LED to red.

Green – No faults

Amber – Unit in standby

Red – Fault condition

The MUTED column shows if the output is muted when the ALARM is active.

HARDWARE ALARMS:

Alarm Type	Fault Name	Unit Faults	
		1	2
UNIT	" +5V Fault"	YES	YES
	" +15V Fault"	YES	YES
	" -15V Fault"	YES	YES
	"Primary DC Fault"	YES	YES
	"Temp Outside Range"	YES	YES
	"Humidity > Range"	YES	YES
	"Ext. Ref Unlocked"	YES	YES
	"100MHz Fault"	YES	YES
	"Coax Switch Fault"	YES	YES
PSU	"PSU 1/2 Voltage Fault"	YES	YES
	"PSU 1/2 Missing Fault"	YES	YES
DEVICE	"Block Current Fault"	YES	NO
	" +3v Fault"	YES	NO
	"DC Feed Fault"	YES	NO
	" +5V Fault"	YES	NO
	"1 <sup>st</sup> LO Fault"	YES	NO
	"2 <sup>nd</sup> LO Fault"	YES	NO
	"Out Of Lock"	YES	NO
	"SHF Fault"	YES	NO
	"External Alarm"	YES	NO
	"External Mute"	YES	NO
	"ASB"	YES	NO
PILOT	"Comms Fault"	NO	YES
	"Out of Lock"	NO	YES

LOG ONLY ALARMS:

Alarm Type	Fault Name
LOG	"LOG Cleared"
	"Power ON"
	"Watchdog Reset"
	"Auto Switch Over"
	"Manual Switch Over"
ETHERNET	"Ethernet Fault"

## 2. INSTALLATION

### 2.1 Care of Your Product

#### 2.1.1 Handling

Single products, when fully packaged for transport can weigh in excess of 12kg's. When multiple Converters are to be delivered at the same time, to the same customer, occasionally two Converters are packaged in the same outer carton, the overall weight can then exceed 20kg's. Care must be taken when attempting to lift or carry these packages.

The shipping carton is qualified for transit of these products and has been used successfully for many years. It will protect against shock and vibration encountered during normal carrier transportation.

PLEASE RETAIN ALL PACKING MATERIALS, including the foam insets. Should the unit need to be returned, return to the address on the front of the manual USING THE ORIGINAL PACKING CARTON, unless it has been seriously damaged.

Avoid subjecting the packaged or unpackaged product to severe shocks.

#### 2.1.2 Unpacking and Inspection

When the product is first received, the outer pack should be inspected for signs of damage. If damage to the outer pack is evident, contact the Carrier immediately and submit a damage report. The equipment should then be removed and inspected for signs of damage, retaining all packing materials. Any visible signs of damage to the equipment should be reported immediately to Peak Communications (electronic photographs of the pack and equipment can help with any subsequent insurance claims). If the equipment appears undamaged, it should be tested for correct operation and again any abnormalities reported to Peak Communications.

When first removing the product from its transit pack, take care to retain all documentation and associated hardware. These products are typically provided with the following items;

- PTR50 series product.
- Operation manual.
- Test results.
- Mains lead (suitable for use in country of operation).
- Spares kit.

If you suspect that any item is missing, please contact Peak Communications immediately.

#### 2.1.3 Storage

Store the product in the normal horizontal orientation, in its outer carton until it is required for use. Do not use the products to support the weight of other items whilst in storage.

Storage temperature range is typically from -40°C to +80°C, avoid exceeding these extremes otherwise damage may result.

Avoid exposing the packaged or unpackaged product to extremes of humidity or moisture (including condensation). In the event that this does occur, the product

should be left at room temperature for in excess of 5 hours to dry naturally before application of prime power.

#### 2.1.4 Cleaning & Maintenance

The product is designed to be installed and operated in a clean air environment. Apart from occasional cleaning of the front panel, no regular cleaning &/or maintenance is necessary.

Always ensure that the product is off-air and that the mains supply is isolated before attempting to clean the front panel. Cleaning of the front panel can be accomplished with a damp cloth. Do not use excessive amounts of water & do not use detergents or other cleaning agents without first consulting Peak Communications.

### 2.2 Mechanical Installation Considerations

#### 2.2.1 Mounting

This product has been designed to mount in a standard IEC 19-inch racking system, but can also be used free standing or mounted in a standard IEC flight case.

The product is of standard 1U height (1.75 inch) and depth of 534mm (21 inches). Standard connector mating parts with cable bend radii, plus space to uncouple connectors, can add a further 80mm (3.15Inches) to this depth & should be considered when designing the installation.

The product is provided with standard 19-inch rack front panel fixing points, however these should not be solely relied upon to support the entire weight of the unit. Four (two on each side) additional M3 mounting points are provided along the sides of the unit, these can be used to support the unit from rack slide rails or other side support mechanisms, alternatively shelving brackets can be used to provide rest support for the units.

Cooling slots are provided on the sides of the unit, care should be taken to avoid blocking these when designing the installation (see Cooling section below).

When several products are to be mounted on top of one another in a rack system, they should not be stacked without individual support. Stacking of units without adequate mechanical support and isolation can degrade microphonic performance of the overall system and hamper maintenance activities.

#### 2.2.2 Cooling

These products dissipate <100W internally and contain an internal forced air cooling system. Air intake and exhaust apertures are provided on the side panels of the chassis, care should be taken to avoid blocking these when designing the installation

Although these products have been designed to operate with a full rack packing density in an ambient of 50°C, for operational reasons it may be necessary to allow extra space if the unit is sandwiched between two longer chassis, or if the rack ambient increases above 50 degrees C. This will be necessary if adjacent equipment

transfer significant heat to the Converter surfaces, through either conduction or convection.

A thermal sensor is fitted to the unit which provides an over temperature alarm

## 2.3 Prime Power Supply & Connection

The safety notes provided in the product compliance section of this handbook should be read before connecting this product to the mains supply.

This product can be operated from mains supplies of 100-132V a.c. or 200-230V AC (50/60Hz), the appropriate voltage range is automatically selected by the unit and requires no user intervention. The IEC standard mains inlet on the rear of the unit includes a double pole switch.

The typical power requirement of these units is <100W.

The equipment is classified in EN 60950 as 'pluggable equipment, class A' for connection to the mains supply, as such it is provided with a mains inlet cord suitable for use in the country of operation. In normal circumstances this will be of an adequate length for installation in the rack. If the mains cord proves to be too short, then any replacement must have a similar fuse type (if fitted) and be manufactured to similar specifications: check for HAR, BASEC or HOXXX-X ratings on the cable. The connector ends should be marked with one of the following: BS1636A (UK free plug 13 amp); BSI, VDE, NF-USE, UL, CSA, OVE, CEBEC, NEMKO, DEMKO, SETI, IMQ, SEV and KEMA-KEUR for the IEC 6 Amp free socket. Schuko and north American free plugs must have similar markings.

The installation of the equipment and the connection to the mains supply must be made in compliance to local or national wiring regulations for a category II impulse over voltage installation. The positioning of the equipment must be such that the mains supply socket outlet for the equipment should be near the equipment and easily accessible or that there should be another suitable means of disconnection from the mains supply.

### 2.3.1 Fuses

The equipment is provided with short circuit fuse protection of both the Live and Neutral conductors, both fuses must be functional before the unit will operate. The fuses are accessible from the rear of the unit and are fitted into the IEC mains inlet. To check or replace a fuse, switch off and isolate the mains supply before removing the fuse cover. If a replacement fuse is required, then an equivalent type and rating must be used. The fuse size is 5 x 20 mm, rated at 5A anti-surge (T5A).

## 2.3.2 Earthing

The equipment is designed to operate from a TN type power supply system as specified in EN 60950. This is a system that has separate earth, line and neutral conductors. The equipment is not designed to operate with an IT power system which has no direct connection to earth.

An external protective earth, providing protection against RF and transient currents, should be connected between the rear panel earth stud (adjacent to the prime power inlet point and fitted with an M4 nut) and a local system earth point.

## 2.4 Other Interface Connections

### 2.4.1 Internal Beacon Receiver L-band Connection

This connection is provided on the rear panel and has the following characteristics;

Converter Type	Connection Type	Panel Label	Impedance
PTR50	N-type (F)	Rx In	50Ω

The use of high quality cables and connectors for L-band signals is strongly recommended. Cables and connectors should be rated for operation up to 2200MHz. Care should be taken when handling these cables, avoiding stress to connections, tight bend radii and damage from sharp objects, all of which can degrade system performance.

These connections can also be used to interface the 10 MHz reference signal (at a nominal 0dBm level) the DC power (up to 20.5V @ 0.5A) and a 22KHz tone to the external Block DownConverter.

### 2.4.2 Internal Beacon Receiver SHF Connection

For units fitted with an internal Beacon Receiver with SHF input option, this connection is provided on the rear panel and has the following characteristics;

Converter Type	Connection Type	Panel Label	Impedance
PTR50	N-type (F)	Rx In	50Ω

The use of high quality cables and connectors for SHF signals is strongly recommended. Cables and connectors should be rated for the frequency of operation. Care should be taken when handling these cables, avoiding stress to connections, tight bend radii and damage from sharp objects, all of which can degrade system performance.

### 2.4.3 Internal Beacon Receiver Auxiliary Output Connection

For units fitted with an auxiliary output connection, this connection is provided on the rear panel and has the following characteristics;

Converter Type	Connection Type	Panel Label	Impedance	Notes.
----------------	-----------------	-------------	-----------	--------

Optional	BNC (F)	Rx Out	0Ω	5mA max
----------	---------	--------	----	---------

#### 2.4.5 External Reference Input Connection Option

This connection is provided on the rear panel and has the following characteristics;

Converter Type	Connection Type	Panel Label	Impedance	Notes.
Optional.	BNC (F)	Ext Ref.	50Ω	Accepts 5 or 10MHz.

#### 2.4.7 Alarms Interface Connection

This is provided on the rear panel and is a standard 'D' type 15-pin (Male). The connections provide access to the various form 'C' relay contacts which indicate alarm conditions.

A pin configuration is given below;

Unit fault (1) COM	1	9	Unit fault (1) N/O
Unit fault (1) N/C	2	10	Not used
Ext. Mute (1)	3	11	Ext. Alarm (1)
Unit fault (2) COM	4	12	Unit fault (2) N/O
Unit fault (2) N/C	5	13	Not used
Not used	6	14	Not used
Not used	7	15	GROUND
Not used	8		

Note: N/O indicates 'normally open' in the non-fail state, with STATUS LED Green.

Unit fault (1) is used for the internal beacon receiver tracking lock status

Unit fault (2) is used for the PTR chassis summary alarm

If there is an overall unit fault then both relays are triggered.

#### 2.4.8 Remote Serial Communications Interface (RS-232/RS-485)

This is provided on the rear panel and is a standard 'D' type 15-pin (F). The units provide both an RS232 port for simple two-way remote control, and an RS485 port for asynchronous, 'multi-drop' remote control applications.

A pin configuration is given below;

RS485 Rx +	1	9	RS485 Rx -
RS485 Tx +	2	10	RS485 Tx -
Not used	3	11	Not used
Not used	4	12	Not used
Not used	5	13	Not used
Not used	6	14	GROUND
RS232 Rx In	7	15	RS232 Tx Out
Not used	8		

When using this product with the serial communications interface, a 120Ω bus termination should be fitted externally between the Rx + (pin 1) and Rx – (pin 9) connections of the 15-way ‘remote’ connector. If used in conjunction with other equipment on a multi-drop system, the bus termination is only required on one unit, typically the furthest from the master device.

A screened cable, terminated to the back-shell of the ‘remote’ connector should be used to prevent RF interference from adversely affecting operation. When connecting the cable screen to the back-shell, ideally a full 360° contact should be made.

For short cable runs (up to 10m), a cable containing a twin twisted pair conductor arrangement is ideal. Typical conductor characteristics would be size 24 AWG, screened with an overall tinned copper braid. For cable runs above 10m, an insulated signal return connection should also be made.

#### 2.4.9 Redundancy Interface Connector

This is provided on the rear panel and is a standard 'D' type 9-pin (M).

The redundancy interface is a standard feature of these units and can be easily configured so that the converters communicate with each other for 1+1 redundancy systems. The units communicate using the CANBUS® interface system.

A pin configuration is given below;

Not used	1	6	GND
CANBUS® Low	2	7	CANBUS® High
GND	3	8	Tell back A
Power A	4	9	Tell back B
Power B	5		

There needs to be 120R termination resistors between the CANBUS® High and CANBUS® Low pins on both ends of the redundancy cable ie. between pins 2 & 7 on the above connections (both ends).



### 3.0 EQUIPMENT OPERATION

The PTR50 series Beacon receiver are predominantly L-Band based and have additional features for integration with external SHF LNB's/ BDC's.

The PTR50 series unit powers and controls the external LNB/Block converter by supplying DC Power and a Locking frequency for the internal oscillator. The PTR50 series can monitor the alarm status of the Block converter to give the operator indication of the state of the outdoor unit. In these situations, the DC and 10MHz signals can be switched on and off and the frequency on the PTR50 unit can be set to include the frequency of the remote Block converter so an SHF display of received frequency is possible.

#### **LCD display contrast adjustment:**

The contrast of the LCD can be changed via the front panel.

To change the contrast press and hold the YES/ENTER key, while holding down this key either press the UP arrow (to lighten the screen) or the down arrow (to darken the screen).

#### **Menu structure overview:**

All facilities are accessed from the front panel, via the menu system. The remote control can interrogate the unit whilst the menu is in use.

The keyboard consists of 16 keys. The block of 4 arrowed keys are used for jumping to associated menus and moving along character strings.

The YES/ENTER is the general confirmation button and the NO/CANCEL is the general abort/step back button.

The 0 to 9 keys are used to set values or to select a menu option. Only one push of the number button is required to select an item

You can change the contrast on the screen by holding in the YES button and pressing arrow UP or arrow DOWN

A short audible beep designates a valid key and a short buzz an invalid key.

### 3.1 Home menu

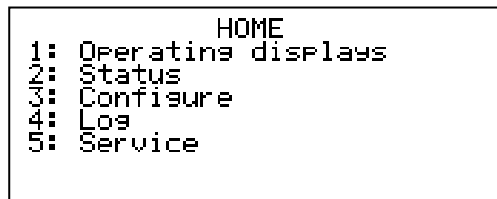

Pic 3.1 HOME menu.

The HOME menu is the base menu from which to perform any function. The HOME menu displays items which are particular to the configuration being used.

Press the appropriate numerical key to select the required sub-menu.

There is also a 'hidden' SETUP menu that can be accessed by pressing key '9' from this menu.

#### 3.1.1 Operating displays



Pic 3.1.1 OPERATING DISPLAYS menu (both options).

The Operating displays screen gives you access to menu items that will be used for everyday use.

Press the appropriate numerical key to select the required sub-menu.

If the internal Beacon Receiver option is not fitted, then this screen will not have the Video Display menu option visible.

##### 3.1.1.2 Rx Level Display Screens

###### 3.1.1.2a Beacon Receiver

The screen shows the Rx frequency and the level of the Beacon in dBm.

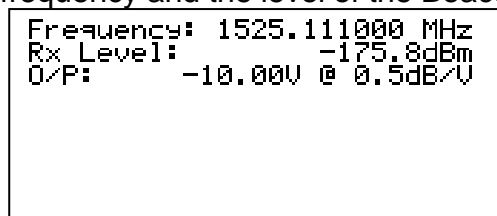

Pic 3.1.1.2.1 OPERATING DISPLAY.

##### 3.1.1.3 Beacon Video Display Screen

This screen is specific for the Beacon Receiver portion of the unit

This screen displays the power of the frequencies inside the video frequency span (VS) where the video centre frequency (CF) is at half the video frequency span of the frequency span. RL is the Reference Level of the incoming signals in dBm.

The video centre frequency and video frequency span can be changed in the Video Display menu. To change the VS press the 'up arrow' to increase the frequency span and 'down arrow' key down to decrease it. The centre frequency can be changed with 1/10<sup>th</sup> of the current video frequency span. Increase the video centre frequency by pressing arrow key right and decrease it by pressing arrow key left.

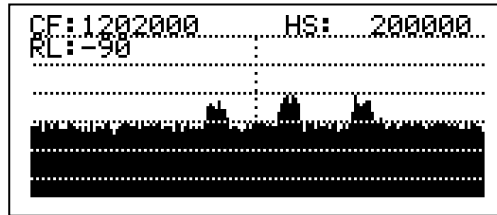

Pic 3.1.1.3 BEACON VIDEO DISPLAY.

### 3.1.2 Status screen

The Status screen shows the user settable parameters. The screen can be scrolled up and down using the arrows keys 'up' and 'down'.

```
----- Unit -----  
PTR50  
Software Version: 2.00  
Serial No.: 00000  
Summary Alarm: FAULT  
External Ref: NOT Present  
----- Remote Control -----  
Local RS232 mode v
```

Pic 3.1.2a PTR STATUS.

While viewing the status screen, the option to press the left or right arrow keys is available; this cycles through different status screens. These include:

- Tracking Receiver
- Unit

### 3.1.3 Configuration screen

The Configuration screen shows menu options which if selected allow the appropriate setting to be changed.

```
CONFIGURE  
1: Tracking Configure  
2: Remote Control  
3: Redundancy
```

Pic 3.1.3a CONFIGURATION screen

#### 3.1.3.2a Tracking Configuration screen

The Beacon Receiver tracking menu screen displays six submenu options, Video, Beacon, Downconverter, RF Input Path, Composite I/P Attenuation, & DC Output Limits.

```
TRACKING CONFIG  
1: Video  
2: Beacon  
3: Down Converter  
4: RF Input Path  
5: Composite I/P Atten.  
6: DC Output Limits
```

Pic 3.1.3.2a TRACKING CONFIGURATION

Pressing key "1" accesses the video configuration. The settings in the video configuration submenu changes settings for the video display screen. For more information about the video configuration see chapter 3.1.3.2a.1 Video Configuration.

Pressing key “2” accesses the beacon configuration menu. Here the configuration for the tracking beacon can be set. For more information about the beacon configuration go to chapter 3.1.3.2a.2 Beacon Configuration.

Pressing key “3” accesses the down converter configuration menu. Here the configuration for the tracking down converter can be set. For more information about the DownConverter configuration please see chapter 3.1.3.2a.3 DownConverter Configuration.

Pressing key “4” accesses the RF Input configuration menu. Here the configuration for the RF Input paths can be set (if this option is fitted). For more information about the RF Input Path configuration please see chapter 3.1.3.2a.4 RF Input Path Configuration.

Pressing key “5” accesses the Composite I/P Attenuator menu. Here the value of the Composite I/P attenuator can be set. For more information about the Composite I/P Attenuator please see chapter 3.1.3.2a.5 Composite I/P Attenuator.

Pressing key “6” accesses the DC Output limits configuration menu. Here the configuration for the tracking down converter can be set. For more information about the DownConverter configuration please see chapter 3.1.3.2a.6 DC Output Limits Configuration.

### 3.1.3.2a.1 Video Configuration

The Video Configuration screen shows 4 menu options. Option one to three will display other menu screens and allow for changing the setting. Chapters 3.1.3.2a.1 to 3.1.3.2a.5 will explain these.

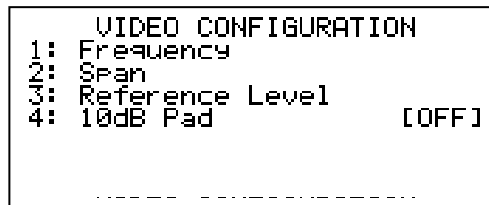

Pic 3.1.3.2a.1 VIDEO CONFIGURATION

Pressing key “4” toggles a 10dB attenuation pad on or off affecting the incoming signal to the video display screen.

#### 3.1.3.2a.1.1 Frequency

The Video Centre Frequency can be changed in the menu screen, see picture (Pic. 3.1.3.2a.1.1) for an example of the menu screen. The two numbers on the third line in the display is the range the video centre frequency can be within. The maximum

deviation from the Rx frequency is 25MHz. Changing the video frequency will affect the Video Frequency span.

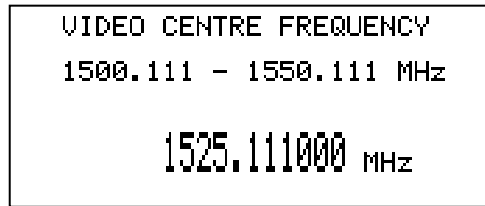

Pic 3.1.3.2a.1.1 FREQUENCY adjustment

The cursor is blinking over the number that is currently changeable. The number can be changed in several ways.

Pressing a number key "0" - "9" change the number to value of the key press and move the cursor to next position.

Pressing the arrow keys up and down increment or decrement the number the cursor is currently over. Pressing the arrows keys left and right changes the position of the cursor without changing the number it is on.

To make the change permanent the change has to be confirmed by pressing the "YES" key. Pressing key "NO" the change will be cancelled.

### 3.1.3.2a.1.2 Span

The Tracking Video Span is the frequency span shown on the video display screen chosen in the operation menu chapter 3.2.1. Picture (Pic. 3.1.3.2a.1.2) shows a Tracking Video Span menu screen.



Pic 3.1.3.2a.1.2 TRACKING SPAN adjustment

The video span is dependent upon the video centre frequency for its maximum limit. When it video centre frequency is equal the Rx frequency, the video has a maximum of 50 MHz centred on the Rx frequency, so  $\pm 25$  MHz. If the video centre frequency is changed in such a way that the video span frequency is too large, the video span will be changed accordingly to only display the new maximum frequency range. The video span frequency can be changed in the same way as the video centre frequency.

### 3.1.3.2a.1.3 Reference Level

The reference level menu screen in the video configuration menu is used to displace the signals on the video display menu. The Reference Level is the top line in the video display screen just above the RF value, see picture (Pic. 3.1.4.1.3a). The range is -80 dB to -100dB. To change the Reference level, use the arrow keys up and down, 5 dB per step.

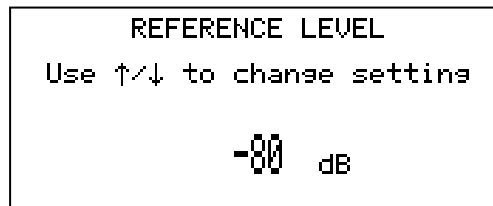

Pic 3.1.3.2.1.3 REFERENCE LEVEL adjustment

Press “YES” to accept the change, “NO” to cancel.

### 3.1.3.2a.1.5 10dB Pad

Allows user to attenuate high-power signals to prevent compression of the video section.

### 3.1.3.2a.2 Beacon Configuration

The beacon configuration menu screen is the menu that is used to configure the beacon tracking. There are five menu options. The first four will take you to submenus the last choice, choice five ASB, toggles the ASB (Anti Side Band) on and off.

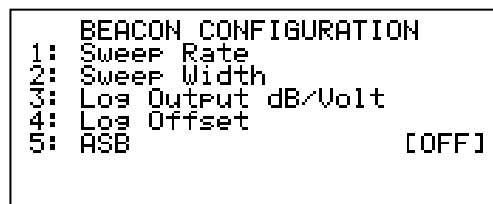

Pic 3.1.3.2a.2 BEACON CONFIGURATION menu



### 3.1.3.2a.2.1 Sweep Rate

The sweep rate is the frequencies the tracking system covers per second inside the frequency range set by the sweep width. In this case the sweep rate is 5 kHz/s, see picture (Pic. 3.1.3.2a.1).

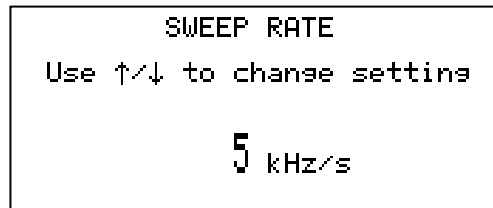

Pic 3.1.3.2a.1 SWEEP RATE adjustment

To change the sweep rate, use the arrow keys up and down. Press key "YES" to accept change, key "NO" to cancel.

### 3.1.3.2a.2.2 Sweep Width

The sweep width is the frequency range in which the beacon tracking system is looking for a tracking beacon. The sweep width centred on the Rx frequency being  $\pm 20$  kHz in this case, see picture (Pic. 3.1.3.2a.2.2), given a total frequency span of 40 kHz starting at the frequency  $Rx_{frequency} - 20$  kHz.

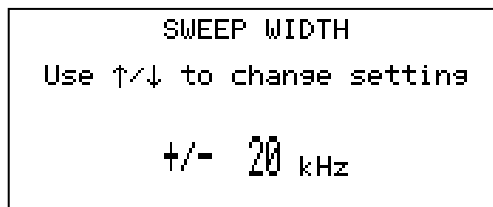

Pic 3.1.3.2a.2.2 SWEEP WIDTH adjustment

To change the sweep width, use the arrow keys up and down. Press key "YES" to accept the change, "NO" to cancel change.

### 3.1.3.2a.2.3 Log Output dB/Volt

The Log Output dB/Volt signal is dependent on the receive signal. Picture (Pic. 3.1.3.2a.2.3) shows the Log Output dB/Volt screen. Notice the line under the title is the actual output voltage.

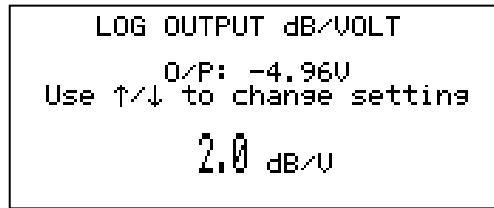

Pic 3.1.3.2a.2.3 LOG OUTPUT adjustment

To change the Output dB/Volt signal use the arrow keys up and down. Press key “YES” to accept change, “NO” to cancel.

### 3.1.3.2a.2.4 Log Offset

The Log Offset makes it possible to offset the voltage output. Picture (Pic. 3.1.3.2a.2.4) shows the Log Offset screen. Notice the line under the title is the actual output voltage.

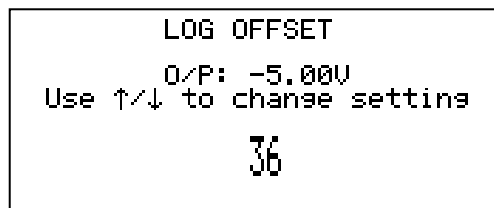

Pic 3.1.3.2a.2.4 LOG OFFSET adjustment

To change the Log Offset voltage, use the arrow keys up and down. Press key “YES” to accept change, “NO” to cancel.

### 3.1.3.2a.2.5 ASB

Allows user to turn on or off the anti-sideband locking function, which prevents the unit from locking to sidebands with power of up to 3dB down from main carrier, the unit will sweep around the locked signal and monitor this bandwidth for such sidebands, if the unit is locked to a sideband the unit will take itself out of lock and continue its original sweep until the unit is locked to the highest CW in band. When 3 full sweeps have been achieved the unit ASB function will automatically disable until loss of lock.

### 3.1.3.2a.3 Down Converter Configuration

The Down Converter Configuration screen displays 5 options, see picture. Options 1,2,3and 6 have submenus of their own.

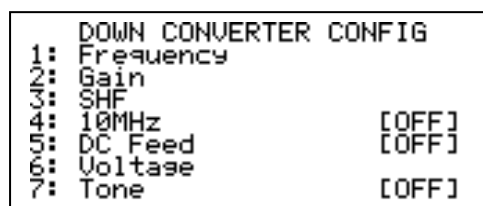

Pic 3.1.3.2a.3 DOWNCONVERTER CONFIGURATION menu

To change the Rx frequency press key “1”. A new menu screen will be displayed where it is possible to change the frequency. This frequency is the frequency the tracking part will try to find a beacon around.

Key press “2” will enter a new menu screen where changing of the signal gain is possible.

To enter the SHF menu press key “3”.

By pressing key “4” it is possible to toggle the 10 MHz on and off.

Pressing key “5” toggles the DC Feed on and off.

The 10MHz and DC are sent up the L-Band connection to lock and power the outside block converter. Note that it may take a few minutes after switching on power and Reference for the outside unit to stabilise and any connected alarm to clear.

### 3.1.3.2a.3.1 Beacon DownConverter Frequency

The Rx Frequency menu screen enables the user to change the receive frequency.

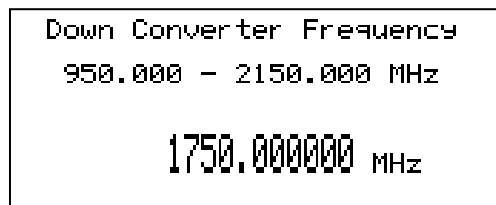

Pic 3.1.3.2a.3.1 DOWNCONVERTER FREQUENCY adjustment

Just below the screen title is the frequency range frequency can be set within.

A cursor should be flashing over the first cipher of the large numbers that shows the frequency at the bottom. Pressing any of the number keys “0” to “9” will set the cipher the cursor is over to that number and move the cursor to the next number. It is possible to increment and decrement the number using the arrow keys up and down. The cursor can be moved left and right by using the arrow keys left or right. If the frequency is out of range the display will display an “!!!!!! Out of Range !!!!!!” message.

To store a selected frequency that is in range use key “YES”. Key press “NO” will cancel and move the screen to previous menu.

### 3.1.3.2a.3.2 Beacon DownConverter Gain

Picture shows the Rx gain menu screen.

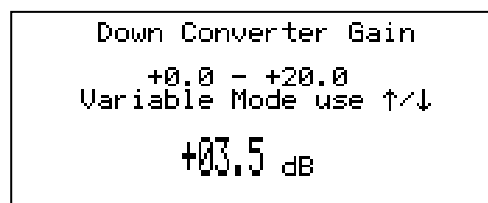

Pic 3.1.3.2a.3.2 DOWNCONVERTER GAIN adjustment

The range for the gain is from 0 to 30 dB as show on the line just below the screen title.

To change the gain, use the arrow keys up and down to increment or decrement that actual gain. To accept the change in gain press key "YES", press "NO" to cancel and return to previous menu screen.

### 3.1.3.2a.3.3 Beacon SHF Frequency Display

SHF stands for SUPER HIGH FREQUENCY and in this context, refers the SHF stage which precedes this L-Band unit.

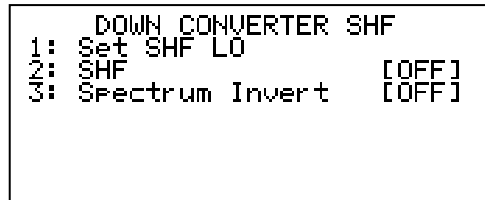

Pic 3.1.3.2a.3.3 SHF FREQUENCY display adjustment

This setting is used as a convenient way to mathematically add the frequency effect of the external LNB or block converter on the downlink chain and display the actual Beacon Frequency.

For a block down converter or an LNB the local oscillator should be determined. This is the number which is added in this menu. To apply this value the SHF has to be switched ON

With Peak Communications equipment the following Local Oscillators apply;

PBD725	X Band DownConverter	6.30GHz
PBD420	C-Band DownConverter	5.15GHz (inverts spectrum)
PBD1095	Ku Band DownConverter	10.0GHz
PBD1170	Ku Band DownConverter	10.75GHz
PBD1225	Ku Band DownConverter	11.30GHz

Use of this feature allows the user to manipulate the unit to show the overall SYSTEM frequency. This is achieved by selecting both the Local Oscillator frequencies of the external SHF Block DownConverter. The SHF LO frequency and Gain/Loss are added/subtracted to the L Band output frequency (not if SHF is OFF) and power to obtain the SYSTEM output frequency and power level.

Example: If a PTR50 series unit is connected to a PBD725 the PTR50 display can be set to show the actual output frequency at Ku Band. The Block converter calculation in this case is simply the addition of the BDC Local Oscillator value to the L-Band frequency. If the input is set to 1200MHz (1.2GHz) and the LO is 6.30GHz the output is  $1.2 + 6.3 = 7.50\text{GHz}$ . IF the 6.30 value is entered as an SHF LO and the feature switched on with SHF ON/OFF you will see that any frequency shown on the unit is at X Band which also means you would have to input any new frequency at X Band.

### 3.1.3.2a.3.4 10MHz

Enables user to send reference frequency to an attached LNB or BDC via the centre pin of RF In

### 3.1.3.2a.3.5 DC Feed

Enables user to send reference DC voltage to an attached LNB or BDC via the centre pin of RF In

### 3.1.3.2a.3.6 Voltage

Enables user to set the value of the reference output voltage of the DC Feed, when the DC Feed is turned on.

### 3.1.3.2a.3.7 Tone

~~Enables user to send a reference 22kHz tone to an attached LNB or BDC via the centre pin of RF In.~~

### 3.1.3.2a.4 RF Input Path Configuration optional

The RF Input Path Configuration screen allows the user to select which RF path the converter is currently using, as well as the settings for this and the alternative RF path. If the PTR does not have the dual RF path option fitted then only one path's setting can be changed.

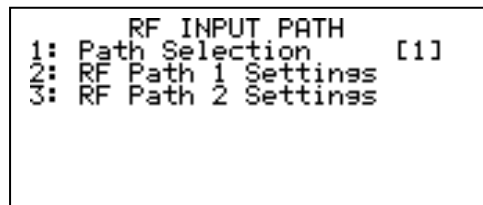

Pic 3.1.3.2a.4 RF INPUT PATH CONFIGURATION menu

To change the RF Path selection press key "1". This cycles through the two available RF Paths.

Keys "2" and "3" allow the user the change various settings for the RF Paths. See section 3.1.3.2a.3 for the various settings, and their usage. Not all the downconverter's settings are available through this menu, just the main ones.

### 3.1.3.2a.5 Composite I/P Attenuation

The Composite I/P Attenuation screen allows the user to modify the composite L-Band input attenuator in the PTR unit.

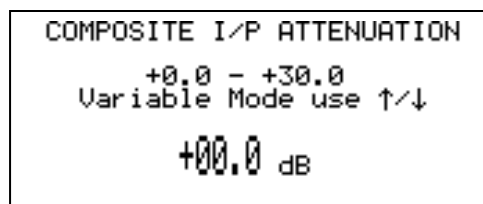

Pic 3.1.3.2a.5 COMPOSITE I/P ATTENUATION menu

To increase the dynamic range and prevent compression of the tracking downconverter, this menu allows the user to change the value of the input attenuator positioned after the internal L-Band input filter.

### 3.1.3.2a.6 DC Output Limits

The DC Output Limits menu screen allows the select then modify either the low output level limit or the high output level limit.

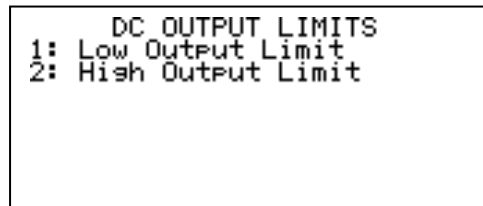

Pic 3.1.3.2a.6 DC OUTPUT LIMITS menu

If the internal tracking board DC output is used with an ACU that can only accept voltages within certain limits, this menu allows the user to set high and low limits of this DC voltage.

### 3.1.3.4 Pilot Configure

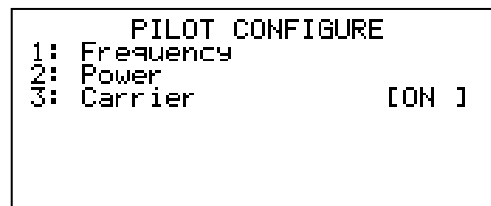

Pic 3.1.3.4 PILOT CONFIGURATION screen

The Pilot Configuration screen shows menu options for the pilot generator option, if this is enabled in the unit.

#### 3.1.3.4.1 Frequency

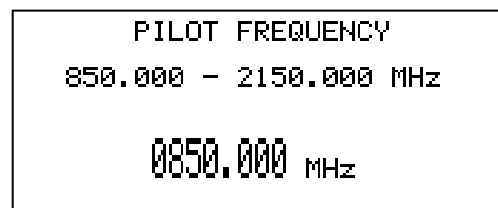

Pic 3.1.3.4.1 Pilot frequency configuration

The pilot frequency configuration menu allows the setting of the pilot frequency, see spec. for limits and step size.

### 3.1.3.4.2 Power

```
PILOT POWER
-80.0 - -20.0 dBm
Variable Mode use ↑/↓
-80.0 dBm
```

Pic 3.1.3.4.2 Pilot frequency configuration

The pilot power configuration menu allows the setting of the pilot power level, see spec for limits and step size.

### 3.1.3.4.3 Carrier

Pressing the '3' key will toggle the pilot carrier ON / OFF.

### 3.1.3.5 Remote Control

This screen provides access to all setup parameters for the remote interface.

```
RS485 (LOCAL Mode)
Address:23
Baudrate:19200
1: Set REMOTE mode
2: Setup RS485
3: Setup RS232
4: Set Protocol [P7xxx]
```

Pic 3.1.3.5 RS485 setup

#### 3.1.3.5.1 Set remote mode

Pressing 1 will toggle the unit into either local or remote mode.

```
CONFIGURE
1: Remote Control

Unit in REMOTE mode
no Configuration available
Change to LOCAL mode for
Configuration changes
```

Pic 3.1.3.5.1 CONFIGURE remote control

Note: In remote mode if you try to access the configuration menu while in remote the screen shown below will be displayed.

#### 3.1.3.5.2 Setup RS485

The RS485 bus address can be set by entering in the number using the numeric keypad. After entering the unit address, the baud rate to be used is selected.

#### 3.1.3.5.3 Setup RS232

The procedure for setting up the RS232 is the same as shown above for the RS485.

### 3.1.3.5.4 Set Protocol

The PTR50 Series of converters only currently supports the P7xxx protocol specified in this manual.

### 3.1.3.5.5 Ethernet (Optional)

If the unit has been fitted with the Ethernet option, the remote-control menus are modified as follows:

```
REMOTE CONTROL
Ethernet (LOCAL Mode)
Address:N/A Baudrate:19200
Confis Port: RS485

1: Set REMOTE mode
2: Set Communications
3: Set Protocol [P7xxx]
```

Pic 3.1.3.5.5a REMOTE CONTROL configuration screen in with Ethernet option

To set communications between RS232, RS485 or Ethernet, option 2 must be selected (Pic. 3.1.3.5.5a).

```
COMMUNICATIONS

1: Setup RS485
2: Setup RS232
3: Setup Ethernet
```

Pic 3.1.3.5.5b COMMUNICATIONS screen

The Setup RS485 and Setup RS232 menu options are the same as described previously. Set Ethernet menu option allows the Ethernet port to be used rather than the RS232/RS485 for remote control.

The menu choices (1-4) shown in Pic 3.1.3.5.5c allow the user to change the relevant Ethernet settings of the unit.

```
ETHERNET OPTIONS 1/2
1: DHCP [Enabled]
2: IPv4 Address
3: Subnet Mask
4: Gateway
5: TCP Port
6: TCP Socket Timeout
7: SNMP [Disabled]
```

Pic 3.1.3.5.5c Ethernet Options screen 1 of 2.

**5 TCP Port** – Sets the TCP port number used that allows serial communications messages to be sent, via TCP, to the unit.

**6 TCP Socket Timeout** – Sets the TCP socket timeout, i.e. the amount of time waited for with no communications before the TCP socket is automatically closed.

**7 SNMP** – Allows the SNMP protocol to be turned Disabled/Enabled.



```
ETHERNET OPTIONS    2/2
1: SNMP Trap Address
2: Set Options
```

Pic 3.1.3.5.5d Ethernet Options screen 2 of 2.

1 *SNMP Trap Address* – Sets the IP address of the device that will receive any SNMP trap error messages from the unit.

2 *Set Options* - Is used to set the Ethernet data all at once on the device, this must be used when trying to change the Ethernet settings.

See section 5.2 for more Ethernet information.

### 3.1.3.6 Redundancy

This screen provides access to all setup parameters for the redundancy.

```
1:1 REDUNDANCY
1: Identifier          [A]
2: Change Over        [N/A]
3: Mode               [AUTO]
4: List Units In System
```

Pic 3.1.3.6.1 Redundancy configuration

#### 3.1.3.6.1 Identifier

The identifier for each unit can be either [A] or [B], care should be taken that the units in a system don't have the same Identifier.

#### 3.1.3.6.2 Change Over

This allows the OFFLINE unit to be moved into the ONLINE position.

#### 3.1.3.6.3 List Units in System

This displays a menu screen showing the other units that can be seen on the same system as this unit. This screen only shows the PTRs it will not show any other external units that are being controlled by the PTRs.

### 3.1.4 Log

The log menu contains three submenus; View, Clear and View graphs, see picture (Pic. 3.1.4a).

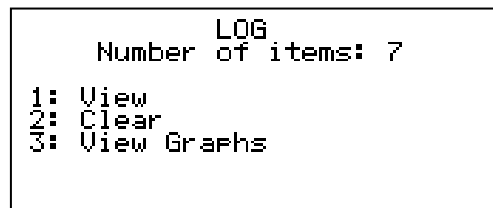

Pic 3.1.4a LOG MENU

Press key “1” on the key pad to view the event log that shows any errors, alarms or events that have happened to the unit. Picture (Pic. 3.1.6.3b) shows the view menu screen. It is possible to page through the log items but pressing the arrow keys ‘up’ and ‘down’.

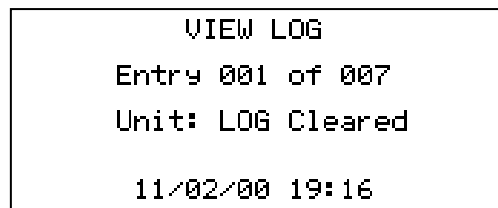

Pic 3.1.4b VIEW LOG

To clear the log, press key “2”. A confirmation menu screen will appear. Press key “YES” to clear the log or “NO” to cancel.

The View Graphs submenu, key press “3”, shows statistics of the unit.

### 3.1.5 Service

This menu is for maintenance personnel only and allows setting of the date and time, LOs inside the unit can be manually changed, fans switched on and off and the 10MHz internal reference frequency can be trimmed. This menu is factory set and it is not recommended that the user changes parameters within this menu without first consulting the factory.

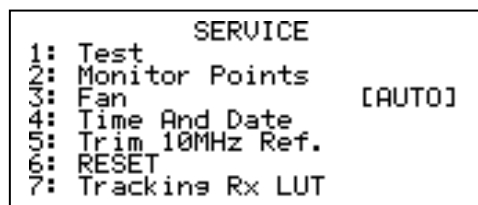

Pic 3.1.5 SERVICE menu

#### 3.1.5.1 Fan

The PTR50 series of converters are fitted with two fans. One fan operates all the time the prime power is applied the second fan can be set to [ON] [OFF] or [AUTO]. In auto mode the fan will operate when the unit internal temperature rises above the set point.

### 3.1.5.2 Tracking Rx LUT

This facility allows the entry of a Look Up Table (LUT) that gives absolute power calibration across the receiver frequency range for use with 1+1 redundancy systems. The LUT helps to match the absolute received level, when two units are used in a system. In use, it can reduce switch over level changes of the tracking receiver paths to within 0.1dB when correctly setup.

If PTR units are ordered in a redundancy configuration then Peak Communications will test all parts as a 'system' to produce a full look up table for both PTR units. These LUT values are stored in the PTR unit and are also recorded in the test results, if the unit is reinitialised for any reason the original values should be re-entered.

Peak Communications create a full LUT covering the whole receive frequency range, allowing for any beacon frequency during use.

If a PTR fails and requires replacement or a 2<sup>nd</sup> PTR and P1000 is added to create a new 1+1 system, then it ideally it needs to be fully tested with the existing online unit to produce a new LUT table, which is quite a time-consuming test that requires a signal generator to simulate the beacon signal across the receiver frequency range.

Alternatively, where the beacon frequency is known, an abridged procedure can be adopted to calibrate at the single frequency:

Note; use these instructions when replacing a unit in an existing redundancy system (one unit will already have correct LUT data entered).

- Connect the full system together with all associated cabling.
- Using the factory settings menu entered by pressing both '0' & '9' keys when in the home screen, go to <modify parameters> then select <PTR>, <redundancy compensation> menu, in this instance one unit will have been corrected for the P1000 unit loss and will have a value shown (nominally 10dB), enter this value into the newly introduced PTR unit. Press 'Yes' key to save value then exit the menu (repeat presses of the 'No' key will take you back to the main menu).
- Select the correct beacon frequency on both units and allow the internal beacon receivers to lock. The existing unit will read the correct absolute received power present at the input of the P1000 unit. The newly introduced PTR unit should now read a similar value, it is now necessary to manipulate the Look Up Table (LUT) on this unit to produce absolute front panel reading exactly the same as the existing unit.
- Record the received level of the unit with the full LUT and note the L-Band frequency
- Record the received level of the unit to be adjusted, the calculated compensation value will be the inverse of the difference between both units.
- By using the service menu on the unit with no LUT entered, select the closest frequency below the required L-Band frequency and input the calculated compensation value, go the LUT frequency closest above the required L-Band beacon frequency and input the same calculated compensation value, now exit the menu and monitor the absolute received power of the two units. They should

now read exactly the same absolute received power, if this is not realised then adjust the two LUT values empirically until the two units read the same.

When there is no LUT data in either unit (when upgrading from a single PTR to a redundant system), then a similar procedure is applicable, but initially both units will need to have a nominal beacon level compensation value entered. One unit is then chosen as the 'reference' and the other unit LUT values must be measured, calculated and inputted.

### 3.2 Setup

```
                SETUP
1: Initial Setup
2: Serial Number
3: Modify Parameters
4: 15dB Pad
5: Program Checksum
```

Pic 3.2 SETUP MENU

This menu is 'hidden' and is intended for maintenance personnel only. It allows setting of the unit type, serial number, modification of parameters & factory setup of the internal operation. This menu is factory set and it is not recommended that the user changes parameters within this menu without consulting the factory as permanent damage to the unit may occur.

The menus are accessible using '0' + '9' keys when in the home screen.

#### 3.2.1 Modify Parameters

This menu and all sub-menus are factory set and it is not recommended that the user changes other parameters within this menu without consulting the factory as permanent damage to the unit may result!

From the SETUP menu, select the MODIFY PARAMETERS screen.

```
                MODIFY PARAMETERS
1: Tracking
2: Unit
```

Pic 3.2.1 MODIFY PARAMETERS MENU

From the MODIFY PARAMETERS screen, selecting any of the items will take you to a PARAMETERS screen that will list the available parameters, an example of which is shown below:

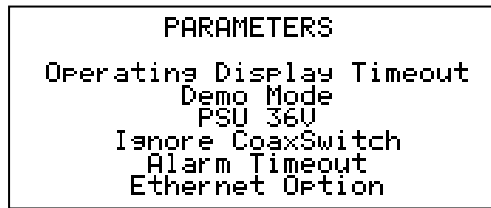

Fig 3.2.2 PARAMETERS MENU

The tables below show a list of parameters and their uses, there are more available but they are not mentioned here as they have special uses and should not be changed without consultation with the factory.

Tracking Parameters:

Parameter	Description
Min Gain	Sets the minimum gain enterable
Max Gain	Sets the maximum gain enterable
Min Frequency	Sets the minimum frequency enterable
Max Frequency	Sets the maximum frequency enterable
Min Gain on Startup	Sets the gain to minimum on restart
Ignore External Alarm	Ignores the external alarm input pin
Ignore External Mute	Ignores the external mute input pin
DAC7216 DtoA Fitted	Selects the DAC type used on the PCB
Video Offset	Tracking receiver video offset
DC O/P Offset	Tracking receiver DC output offset

Unit Parameters:

Parameter	Description
Operating Display Timeout	Not used anymore
Demo Mode	Puts the unit into demo mode, forces all the unit voltages and faults to OK.
PSU 36V	If ON, this says the unit has a 36V PSU, otherwise it is the now normal 27V
Ignore CoaxSwitch	Ignores the coax switches with regards to passive 1:1 redundancy.
Alarm Timeout	The timeout in seconds after which the alarms are read on start-up.
Ethernet Option	Selects the type of Ethernet board used in the unit, the choices are: Digi – new Ethernet with SNMP support Moxa – old Ethernet without SNMP support None – no Ethernet Default is OFF
Tracking Temp Compen	Turns the tracking receiver compensation on/off, the default is ON
Remote Version	This option allows the software to emulate the remote control of the software version selected here. See section 5.2.

## 4. REDUNDANCY

The PTR50 series of beacon tracking receivers interface with the Peak CANBUS® system for 1+1 redundancy.

### 4.1 1+1 Redundancy (switched)

For 1+1 switched redundant operation a pair of matching PTR50 series units is required along with a P1000 series switch unit.

Description of P1000 Series units, P1002L (dual channel unit) shown in drawing below

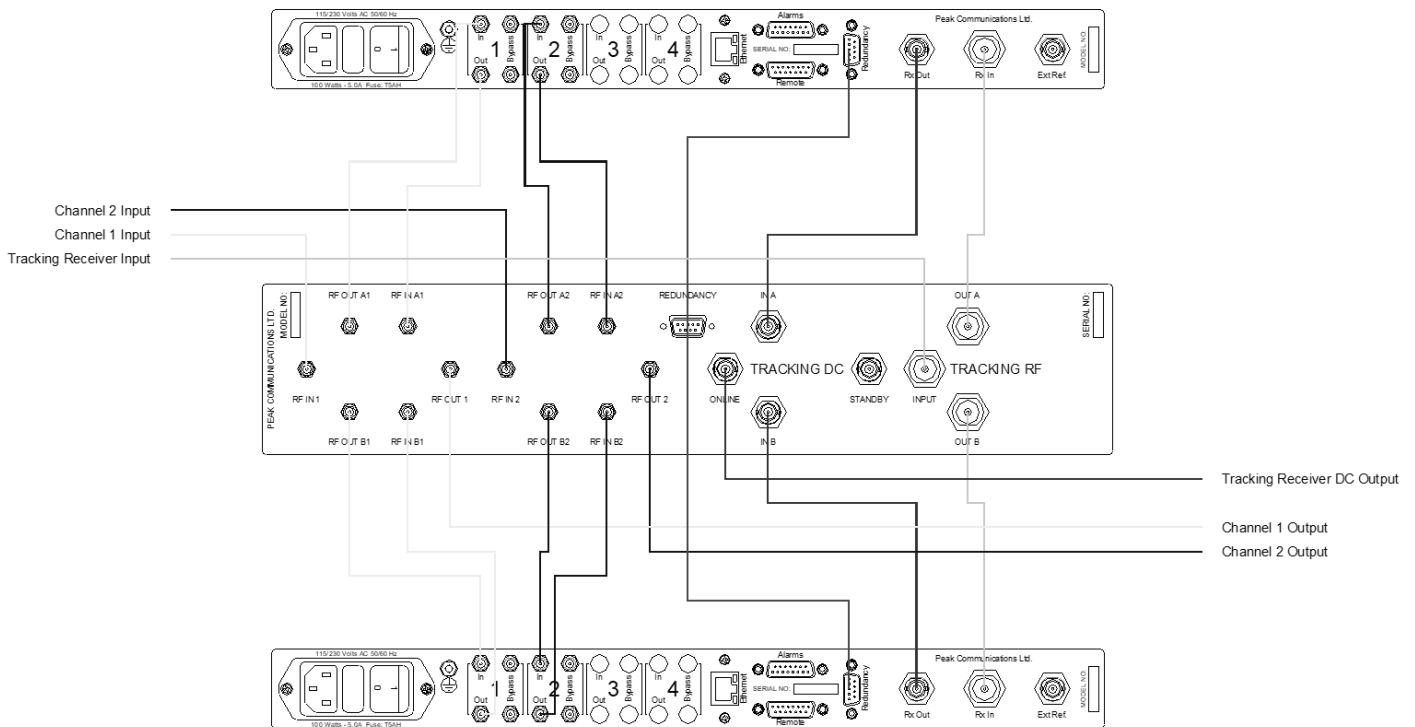

The tracking section utilises a DC and 10MHz pass, L-Band power splitter along with a 6dB DC pass RF attenuator to allow channel matching when a port is disconnected. RF power is therefore attenuated by 10dB between Tracking RF input and the two RF outputs.

There is a menu in the PTR50 units to negate this power loss from the front panel absolute received power reading, if this has not been added at the factory during test then it is located by the following selection

From home screen, press 0, 9. This enters a factory menu, select modify parameters, then select PTR50 and then select Beacon Level Compensation. Enter the value of 10dB in this instance.

10MHz power is attenuated by 4dB between Tracking RF input and the two RF outputs. DC attenuation is negligible and will pass 1Amp at 22V

In use the 10MHz is only selected from the online unit, DC is selected from both the online and offline converters. On switch over the loss of 10MHz during switchover time can result in LNB frequency loss and therefore tracking receiver loss, this must be

allowable in the tracking system if an externally referenced LNB is used. If this cannot be tolerated then a separate LNB driver unit must be used.

In use, one unit is set to identifier "A" and the other to identifier "B". The P1000 series unit is connected to the rear panel 9-way connector with the supplied cables and the units will self-detect and set one unit to online and the other will be set to standby. All parameters are constantly passed from the online unit to the offline unit; this requires any changes to be made to the configuration of both units to be made on only the online PTR50 unit. A changeover will be caused by an alarm detected in the online unit or changeover (keypad 2) being selected, this will result in the standby taking over the RF + DC path, making itself the online unit.

A manual changeover can be made by selecting the correct option from the standby unit, note that this option is only available on the offline unit.

The Tracking DC section is a DC rated transfer switch allowing online and offline monitoring of the individual tracking receiver DC received strength voltage, careful use of the DC output voltage offset menu must be used to match the voltages present during site installation, as this is one of the few parameters not to be transferred via the CANBUS® connector due to the analogue nature of the circuitry

Changeover time between a failed online unit and good offline unit is around 3s, during this time the RF path will fall-back to the PTR50 failsafe path if the option has been fitted. It is critical that the failsafe external path attenuation is carefully selected to function correctly in this instance.

Units ordered in a 1:1 configuration are set during final test to have minimal absolute RF detection level variation, this test is only performed as required, if the system must have a replacement PTR50 introduced then this variation test must be performed by request.

The offline unit in a redundancy system, as stated above, has its settings continually updated through the online unit, as such the configuration menus are not available, other than the Redundancy and Remote control. This is also true for the serial port and web interfaces.

## 5. REMOTE CONTROL

The unit is currently only capable of P7xxx remote control protocols

### 5.1 P7xxx Protocol

The unit transmits and receives data serially in an asynchronous format using the standard ASCII character set. The serial data consists of message frames composed of the following message characters: STX, BYTE COUNT, DEVICE ADDRESS, INSTRUCTION, BODY, CHECKSUM, ETX. All characters are compulsory except for the message body. The presence of a message body is determined by the message type (INSTRUCTION). The total number of message characters in a message frame may range from a minimum of 6 to a maximum of 255.

The remote control follows the following protocol: (in byte form)

[STX] start of message character #02

[B] char defining how many characters are in the message including the STX & ETX parts.

[A] **Address of unit.** Address ranges from ASCII character 001 to 255.

[I] **Instruction number**  
See List below

[MESSAGE]

Numerous characters from length 0 upwards

[CHKSUM]

The checksum is used to verify the accuracy of the message frame. The checksum is defined as the summation of all the bytes in the message, **beginning** with the 3rd byte (DEVICE ADDRESS) and extending through the body of the message, **ending** with the last byte before the checksum. The total of the bytes is then ANDed with 255 so that the checksum is truncated to a single byte.

[ETX] End of transmission character #03

All message to and from the unit follow the above protocol with a character format of 8 data bits, one stop bit, no parity, baud rate 19200, 9600, 4800, 2400, 1200 or 300. Note; that all numeric values are shown as decimal.



**Instruction Number List: (in decimal) :**

To PTR50 unit	From PTR50 unit	Description
20		Requests Tracking / Pilot generator status / Dual PSU status / etc
	21	Responds with status
22		Requests setting changes
24		Set Remote/Local Mode request
30		Requests the number of unread alarm log entries
	31	Responds with number of unread alarm log entries
32		Requests alarm log entry
	33	Responds with alarm log
34		Requests alarm log clear
36		Requests next unread alarm log entry
	37	Responds with next unread alarm log entry
40		Asks for the main Unit settings
	41	Replies with the Unit Settings
45		Requests redundancy status
	46	Responds with redundancy status
47		Requests redundancy changes

**Instruction 20 (Tracking receiver / UPC / External beacon receiver / EXP Status Request):**

Message Byte No.	Set Value / (example)	Length (bytes)	Description
1	02	1	STX
2	?	1	No of bytes in message
3	?	1	Address
4	20	1	Message instruction
5	('K')	1	Device we are asking the information for: 'K' = Tracking Receiver 'i' = Pilot Generator 'A' = Composite Attenuation 'F' = RF Paths 'L' = DC Output Limits 'X' = Extended Message (option 16 only!)
6	?	1	Checksum
7	03	1	ETX

**Instruction 20 (Pilot Generator Request):**

Message Byte No.	Set Value / (example)	Length (bytes)	Description
1	02	1	STX
2	?	1	No of bytes in message
3	?	1	Address
4	20	1	Message instruction
5	('i')	1	'i' = Pilot Generator
6	?	1	Checksum
7	03	1	ETX

**Instruction 20 (Dual PSU Request):**

If the unit doesn't have the dual PSUs fitted this message is ignored.

Message Byte No.	Set Value / (example)	Length (bytes)	Description
1	02	1	STX
2	?	1	No of bytes in message
3	?	1	Address
4	20	1	Message instruction
5	('p')	1	'p' = PSUs
6	?	1	Checksum
7	03	1	ETX

**Instruction 20 (Composite Input Attenuation):**

Message Byte No.	Set Value / (example)	Length (bytes)	Description
1	02	1	STX
2	?	1	No of bytes in message
3	?	1	Address
4	20	1	Message instruction
5	('A')	1	'A' = Composite Input Attenuation
6	?	1	Checksum
7	03	1	ETX

**Instruction 20 (RF Paths):**

Message Byte No.	Set Value / (example)	Length (bytes)	Description
1	02	1	STX
2	?	1	No of bytes in message
3	?	1	Address
4	20	1	Message instruction
5	('F')	1	'F' = RF Paths
6	?	1	Checksum
7	03	1	ETX

**Instruction 20 (DC Output Limits):**

Message Byte No.	Set Value / (example)	Length (bytes)	Description
1	02	1	STX
2	?	1	No of bytes in message
3	?	1	Address
4	20	1	Message instruction
5	('L')	1	'L' = DC Output Limits
6	?	1	Checksum
7	03	1	ETX

**Instruction 20 (Extended Ku Band Attenuation & Composite Power Status Request):**

Message Byte No.	Set Value / (example)	Length (bytes)	Description
1	02	1	STX
2	?	1	No of bytes in message
3	?	1	Address
4	20	1	Message instruction
5	'X'	1	Extended Message
6	'1'	1	Sub-extended message. Ask for Ku Band attenuation setting
7	?	1	Checksum
8	03	1	ETX

**Instruction 21 (Tracking Status Request Reply [L-Band Beacon Input]):**

Message Byte No.	Set Value / (example)	Length (bytes)	Description
1	02	1	STX
2	?	1	No of bytes in message
3	?	1	Address
4	21	1	Message instruction
5	('K')	1	Device we are asking the information on: 'K' = Tracking
6	('01202000000' = 01.202000000 Ghz)	11	Video Centre Frequency in Hz
17	('20000000' = 20MHz)	8	Frequency Span in Hz Span max 25 MHz
25	('080' = -80dB)	4	Video Reference Level in dB
29	('1')	1	Band Width Resolution in kHz 1 = 1 kHz, 6 = 6 kHz
30	('1')	1	10 dB Pad ON/OFF '0' = OFF '1' = ON
31	('1')	1	Sweep Rate Index 0 – 7 0 = "2.5 kHz/s" 1 = "5 kHz/s", 2 = "10 kHz/s", 3 = "20 kHz/s", 4 = "40 kHz/s", 5 = "80 kHz/s" 6 = "120 kHz/s" 7 = "240 kHz/s"
32	('1')	1	Sweep Width Index 0 – 4 0 = "+/- 20 kHz" 1 = "+/- 50 kHz" 2 = "+/- 100 kHz" 3 = "+/- 200 kHz" 4 = "+/- 500 kHz"
33	('1')	1	Log dB/Volt Index 0 – 4 0 = 0.5 dB/Volt 1 = 1 dB/Volt 2 = 2 dB/Volt 3 = 5 dB/Volt 4 = 10 dB/Volt
34	('080')	3	Log Offset 000 – 100.
37	('0')	1	ASB ON/OFF '0' = OFF '1' = ON
38	('+0467')	5	DC Output. Divide by 100 to get the actual voltage.
43	('+0467')	5	Rx Level in 0.1dB steps
48	('10123456789' = 10.123456789 GHz)	11	Frequency in Hz The frequency of the unit.
59	('+0123' = 12.3 dB)	5	Gain in 0.1dB steps
64	('X')	1	Not used
65	('1')	1	10MHz ON/OFF '0' = OFF '1' = ON
66	('1')	1	DC Feed ON/OFF '0' = OFF '1' = ON
67	('01')	2	DC Feed Voltage '01' = 13.0V '02' = 13.3V '03' = 13.7V '04' = 14.0V '05' = 14.3V '06' = 14.7V '07' = 15.0V

			'08' = 18.0V '09' = 18.5V '10' = 18.8V '11' = 19.2V '12' = 19.5V '13' = 19.8V '14' = 20.0V '15' = 20.5V *new in version 2.00
69	('1')	1	22kHz Tone ON/OFF '0' = OFF '1' = ON *new in version 2.00
70	('1')	1	SHF LO ON/OFF '0' = OFF '1' = ON
71	('20123456789' = 20.123456789 GHz)	11	SHF Frequency in Hz
82	('1')	1	SHF Spectrum Invert ON/OFF '0' = OFF '1' = ON
83	('0')	1	Tracking Out of Lock '0' = OK '1' = FAULT
84	('0')	1	2ND LO Fault '0' = OK '1' = FAULT
85	('23/12/02 12:34:56')	17	OK Since time/date string, if there is a fault with this part of the unit then the string is blank.
102	?	1	Checksum
103	03	1	ETX

**Instruction 21 (Tracking Status Request Reply [Non L-Band Beacon Input]):**

Message Byte No.	Set Value / (example)	Length (bytes)	Description
1	02	1	STX
2	?	1	No of bytes in message
3	?	1	Address
4	21	1	Message instruction
5	('K')	1	Device we are asking the information on: 'K' = Tracking
6	('01202000000' = 01.202000000 Ghz)	11	Video Centre Frequency in Hz
17	('20000000' = 20MHz)	8	Frequency Span in Hz Span max 25MHz
25	('080' = -80dB)	4	Video Reference Level in dB
29	('1')	1	Band Width Resolution in kHz 1 = 1 kHz, 6 = 6 kHz
30	('1')	1	10 dB Pad ON/OFF '0' = OFF '1' = ON
31	('1')	1	Sweep Rate Index 0 – 7 0 = "2.5 kHz/s" 1 = "5 kHz/s", 2 = "10 kHz/s", 3 = "20 kHz/s", 4 = "40 kHz/s", 5 = "80 kHz/s" 6 = "120 kHz/s" 7 = "240 kHz/s"
32	('1')	1	Sweep Width Index 0 – 4 0 = "+/- 20 kHz" 1 = "+/- 50 kHz" 2 = "+/- 100 kHz" 3 = "+/- 200 kHz" 4 = "+/- 500 kHz"
33	('1')	1	Log dB/Volt Index 0 – 4 0 = 0.5 dB/Volt 1 = 1 dB/Volt 2 = 2 dB/Volt 3 = 5 dB/Volt 4 = 10 dB/Volt
34	('080')	3	Log Offset 000 – 100.
37	('0')	1	ASB ON/OFF '0' = OFF '1' = ON
38	('+0467')	5	DC Output. Divide by 100 to get the actual voltage.
43	('+0467')	5	Rx Level in 0.1dB steps
48	('10123456789' = 10.123456789 GHz)	11	Frequency in Hz The frequency of the unit.
59	('+0123' = 12.3 dB)	5	Gain in 0.1dB steps
64	('X')	1	Not used
65	('X')	1	Not used
66	('X')	1	Not used
67	('X')	2	Not used *new in version 2.00
69	('X')	1	Not used *new in version 2.00
70	('X')	1	Not used
71	('XXXXXXXXXXXX')	11	Not used
82	('X')	1	Not used
83	('0')	1	Tracking Out of Lock '0' = OK '1' = FAULT
84	('0')	1	2ND LO Fault '0' = OK '1' = FAULT

85	('0')	1	SHF Fault '0' = OK '1' = FAULT Note this byte is only in the message if the unit has been fitted with options 2a-2e.
86	('23/12/02 12:34:56')	17	OK Since time/date string, if there is a fault with this part of the unit then the string is blank.
103	?	1	Checksum
104	03	1	ETX



**Instruction 21 (Pilot Generator Status Request Reply):**

Message Byte No.	Set Value / (example)	Length (bytes)	Description
1	02	1	STX
2	?	1	No of bytes in message
3	?	1	Address
4	21	1	Message instruction
5	('i')	1	Device we are asking the information on: 'i' = Pilot generator
6	('085012500000' = 850.125MHz)	11	Frequency in Hz
17	(' -20.5' = -20.5dBm)	5	Power
22	('1')	1	Carrier ON/OFF '0' = OFF '1' = ON
23	('0' = OK)	1	Summary Alarm OK/FAULT '0' = OK '1' = FAULT
24	('0')	1	Internal comms OK/FAULT '0' = OK '1' = FAULT
25	('0')	1	Pilot Lock OK/FAULT '0' = OK '1' = FAULT
26	('23/12/02 12:34:56')	17	OK Since time/date string, if there is a fault with this part of the unit then the string is blank.
43	?	1	Checksum
44	03	1	ETX

**Instruction 21 (Dual PSUs Status Request Reply):**

Message Byte No.	Set Value / (example)	Length (bytes)	Description
1	02	1	STX
2	?	1	No of bytes in message
3	?	1	Address
4	21	1	Message instruction
5	('p')	1	Device we are asking the information on: 'p' = PSUs
6	('0')	1	PSU 1 – State '0' = OK, 'X' = Missing, '!' = Fault
7	('xxxxx')	5	Not Used
12	('1')	1	PSU 1 – Voltage fault '0' = OK '1' = FAULT
13	('1')	1	PSU 1 – Missing fault '0' = OK '1' = FAULT
14	('xxx')	3	Not Used
17	('0')	1	PSU 2 – State '0' = OK, 'X' = Missing, '!' = Fault
18	('xxxxx')	5	Not Used
23	('1')	1	PSU 2 – Voltage fault '0' = OK '1' = FAULT
24	('1')	1	PSU 2 – Missing fault '0' = OK '1' = FAULT
25	('xxx')	3	Not Used
28	?	1	Checksum
29	03	1	ETX

**Instruction 21 (Send Composite Attenuation Status Request Reply):**

Message Byte No.	Set Value / (example)	Length (bytes)	Description
1	02	1	STX
2	?	1	No of bytes in message
3	?	1	Address
4	21	1	Message instruction
5	('A')	1	Device we are asking the information on: 'A' = Composite Attenuation
6	'1'	1	Sub-extended message. Composite attenuation setting message
7	(' +123' = 12.3 dB)	4	Composite attenuation in 0.1dB steps
11	('<')	1	IF Composite Power condition, used in combination with the IF Composite Power field, e.g. < -50dBm Possible values are: '<' – less than '>' – greater than '=' - equals
12	(' -0500' = -50.0 dBm)	5	IF Composite Power in 0.1dBm steps
17	('0')	1	IF Compression Warning '0' = OK '1' = WARNING
18	?	1	Checksum
19	03	1	ETX

**Instruction 21 (RF Paths):**

Message Byte No.	Set Value / (example)	Length (bytes)	Description
1	02	1	STX
2	?	1	No of bytes in message
3	?	1	Address
4	21	1	Message instruction
5	('F')	1	'F' = RF Paths
6	('1')	1	RF Input path '1' = Path 1 '2' = Path 2
7	('10123456789' = 10.123456789 GHz)	11	Frequency in Hz The frequency of the unit.
Path 1 Settings			
18	(' +0123' = 12.3 dB)	5	Gain in 0.1dB steps
23	('1')	1	10MHz ON/OFF '0' = OFF '1' = ON
24	('1')	1	DC Feed ON/OFF '0' = OFF '1' = ON
25	('01')	2	DC Feed Voltage '01' = 13.0V '02' = 13.3V '03' = 13.7V '04' = 14.0V '05' = 14.3V '06' = 14.7V '07' = 15.0V '08' = 18.0V '09' = 18.5V '10' = 18.8V '11' = 19.2V '12' = 19.5V '13' = 19.8V '14' = 20.0V '15' = 20.5V *new in version 2.00
27	('1')	1	22kHz Tone ON/OFF

			'0' = OFF '1' = ON
28	('XXXX')	4	Not Used
Path 2 Settings			
32	('+0123' = 12.3 dB)	5	Gain in 0.1dB steps
37	('1')	1	10MHz ON/OFF '0' = OFF '1' = ON
38	('1')	1	DC Feed ON/OFF '0' = OFF '1' = ON
39	('01')	2	DC Feed Voltage '01' = 13.0V '02' = 13.3V '03' = 13.7V '04' = 14.0V '05' = 14.3V '06' = 14.7V '07' = 15.0V '08' = 18.0V '09' = 18.5V '10' = 18.8V '11' = 19.2V '12' = 19.5V '13' = 19.8V '14' = 20.0V '15' = 20.5V *new in version 2.00
41	('1')	1	22kHz Tone ON/OFF '0' = OFF '1' = ON
42	('XXXX')	4	Not Used
46	?	1	Checksum
47	03	1	ETX

**Instruction 21 (DC Output Limits):**

Message Byte No.	Set Value / (example)	Length (bytes)	Description
1	02	1	STX
2	?	1	No of bytes in message
3	?	1	Address
4	21	1	Message instruction
5	('L')	1	'L' = DC Output Limits
6	('0')	1	Lower Limit '0' = 0 Volts '1' = -5 Volts '2' = -10 Volts
7	('0')	1	Lower Limit '0' = 0 Volts '1' = +5 Volts '2' = +10 Volts
8	?	1	Checksum
9	03	1	ETX

**Instruction 21 (Extended Ku Band Attenuation & Composite Power Status Reply):**

Message Byte No.	Set Value / (example)	Length (bytes)	Description
1	02	1	STX
2	?	1	No of bytes in message
3	?	1	Address
4	21	1	Message instruction
5	'X'	1	Extended Message
6	'1'	1	Sub-extended message. Ku Band attenuation setting message
7	(' +123' = 12.3 dB 'MAX!' = Maximum dB)	4	Ku Band attenuation in 0.1dB steps Or 'MAX!' if the attenuator has been set to maximum level.
11	('<')	1	IF Composite Power condition, used in combination with the IF Composite Power field, e.g. < -50dBm Possible values are: '<' – less than '>' – greater than '=' - equals
12	(' -0500' = -50.0 dBm)	5	IF Composite Power in 0.1dBm steps
17	('0')	1	IF Compression Warning '0' = OK '1' = WARNING
18	?	1	Checksum
19	03	1	ETX

**Instruction 22 (Tracking Settings Change Request [L-Band Beacon Input]):**

Message Byte No.	Set Value / (example)	Length (bytes)	Description
1	02	1	STX
2	?	1	No of bytes in message
3	?	1	Address
4	21	1	Message instruction
5	('K')	1	Device we are asking the information on: 'K' = Tracking
6	('01202000000' = 01.202000000 GHz)	11	Video Centre Frequency in Hz
17	('20000000' = 20MHz)	8	Frequency Span in Hz Span max 25MHz
25	('080' = -80dB)	4	Video Reference Level in dB Range: -80dB to -100dB in 5dB steps
29	('1')	1	Band Width Resolution in kHz 1 = 1 kHz, 6 = 6 kHz
30	('1')	1	10 dB Pad ON/OFF '0' = OFF '1' = ON
31	('1')	1	Sweep Rate Index 0 – 7 0 = "2.5 kHz/s" 1 = "5 kHz/s", 2 = "10 kHz/s", 3 = "20 kHz/s", 4 = "40 kHz/s", 5 = "80 kHz/s" 6 = "120 kHz/s" 7 = "240 kHz/s"
32	('1')	1	Sweep Width Index 0 – 4 0 = "+/- 20 kHz" 1 = "+/- 50 kHz" 2 = "+/- 100 kHz" 3 = "+/- 200 kHz" 4 = "+/- 500 kHz"
33	('1')	1	Log dB/Volt Index 0 – 4 0 = 0.5 dB/Volt 1 = 1 dB/Volt 2 = 2 dB/Volt 3 = 5 dB/Volt 4 = 10 dB/Volt
34	('080')	3	Log Offset 000 – 100.
37	('0')	1	ASB ON/OFF '0' = OFF '1' = ON
38	('10123456789' = 10.123456789 GHz)	11	The frequency of the unit in Hz
49	('+0123' = 12.3 dB)	5	Gain in 0.1dB steps
54	('X')	1	Not used
55	('1')	1	10MHz ON/OFF '0' = OFF '1' = ON
56	('1')	1	DC Feed ON/OFF '0' = OFF '1' = ON
57	('01')	2	DC Feed Voltage '01' = 13.0V '02' = 13.3V '03' = 13.7V '04' = 14.0V '05' = 14.3V '06' = 14.7V '07' = 15.0V

			'08' = 18.0V '09' = 18.5V '10' = 18.8V '11' = 19.2V '12' = 19.5V '13' = 19.8V '14' = 20.0V '15' = 20.5V *new in version 2.00
59	('1')	1	22kHz Tone ON/OFF '0' = OFF '1' = ON *new in version 2.00
60	('1')	1	SHF LO ON/OFF '0' = OFF '1' = ON
61	('20123456789' = 20.123456789 GHz)	11	SHF Frequency in Hz
72	('1')	1	SHF Spectrum Invert ON/OFF '0' = OFF '1' = ON
73	?	1	Checksum
74	03	1	ETX

**Instruction 22 (Tracking Settings Change Request [L-Band Beacon Input]):**

Message Byte No.	Set Value / (example)	Length (bytes)	Description
1	02	1	STX
2	?	1	No of bytes in message
3	?	1	Address
4	21	1	Message instruction
5	('K')	1	Device we are asking the information on: 'K' = Tracking
6	('01202000000' = 01.202000000 GHz)	11	Video Centre Frequency in Hz
17	('20000000' = 20MHz)	8	Frequency Span in Hz Span max 25MHz
25	(' -080' = -80dB)	4	Video Reference Level in dB Range: -80dB to -100dB in 5dB steps
29	('1')	1	Band Width Resolution in kHz 1 = 1 kHz, 6 = 6 kHz
30	('1')	1	10 dB Pad ON/OFF '0' = OFF '1' = ON
31	('1')	1	Sweep Rate Index 0 – 7 0 = "2.5 kHz/s" 1 = "5 kHz/s", 2 = "10 kHz/s", 3 = "20 kHz/s", 4 = "40 kHz/s", 5 = "80 kHz/s" 6 = "120 kHz/s" 7 = "240 kHz/s"
32	('1')	1	Sweep Width Index 0 – 4 0 = "+/- 20 kHz" 1 = "+/- 50 kHz" 2 = "+/- 100 kHz" 3 = "+/- 200 kHz" 4 = "+/- 500 kHz"
33	('1')	1	Log dB/Volt Index 0 – 4 0 = 0.5 dB/Volt 1 = 1 dB/Volt 2 = 2 dB/Volt 3 = 5 dB/Volt 4 = 10 dB/Volt
34	('080')	3	Log Offset 000 – 100.
37	('0')	1	ASB ON/OFF '0' = OFF '1' = ON
38	('10123456789' = 10.123456789 GHz)	11	The frequency of the unit in Hz
49	('+0123' = 12.3 dB)	5	Gain in 0.1dB steps
54	('X')	1	Not used
55	('X')	1	Not used
56	('X')	1	Not used
57	('X')	2	Not used *new in version 2.00
59	('X')	1	Not used *new in version 2.00
60	('X')	1	Not used
61	('XXXXXXXXXXXXX')	11	Not used
72	('X')	1	Not used
73	?	1	Checksum
74	03	1	ETX

**Instruction 22 (Pilot Generator Setting Change Request):**

Message Byte No.	Set Value / (example)	Length (bytes)	Description
1	02	1	STX
2	?	1	No of bytes in message
3	?	1	Address
4	21	1	Message instruction
5	('i')	1	Device we are asking the information on: 'i' = Pilot generator
6	('085012500000' = 850.125MHz)	11	Frequency in Hz
17	(' -20.5' = -20.5dBm)	5	Power
22	('1')	1	Carrier ON/OFF '0' = OFF '1' = ON
23	?	1	Checksum
24	03	1	ETX

**Instruction 22 (Composite IF Attenuation Reconfiguration Request Reply):**

Message Byte No.	Set Value / (example)	Length (bytes)	Description
1	02	1	STX
2	?	1	No of bytes in message
3	?	1	Address
4	21	1	Message instruction
5	'A'	1	'A' = Composite Attenuation
6	(' +123' = 12.3 dB)	4	Composite attenuation in 0.1dB steps
10	?	1	Checksum
11	03	1	ETX



**Instruction 22 (RF Paths):**

Message Byte No.	Set Value / (example)	Length (bytes)	Description
1	02	1	STX
2	?	1	No of bytes in message
3	?	1	Address
4	22	1	Message instruction
5	('F')	1	'F' = RF Paths
6	('1')	1	RF Input path '1' = Path 1 '2' = Path 2
7	('10123456789' = 10.123456789 GHz)	11	Frequency in Hz The frequency of the unit.
Path 1 Settings			
18	('+0123' = 12.3 dB)	5	Gain in 0.1dB steps
23	('1')	1	10MHz ON/OFF '0' = OFF '1' = ON
24	('1')	1	DC Feed ON/OFF '0' = OFF '1' = ON
25	('01')	2	DC Feed Voltage '01' = 13.0V '02' = 13.3V '03' = 13.7V '04' = 14.0V '05' = 14.3V '06' = 14.7V '07' = 15.0V '08' = 18.0V '09' = 18.5V '10' = 18.8V '11' = 19.2V '12' = 19.5V '13' = 19.8V '14' = 20.0V '15' = 20.5V *new in version 2.00
27	('1')	1	22kHz Tone ON/OFF '0' = OFF '1' = ON
28	('XXXX')	4	Not Used
Path 2 Settings			
32	('+0123' = 12.3 dB)	5	Gain in 0.1dB steps
37	('1')	1	10MHz ON/OFF '0' = OFF '1' = ON
38	('1')	1	DC Feed ON/OFF '0' = OFF '1' = ON
39	('01')	2	DC Feed Voltage '01' = 13.0V '02' = 13.3V '03' = 13.7V '04' = 14.0V '05' = 14.3V '06' = 14.7V '07' = 15.0V '08' = 18.0V '09' = 18.5V '10' = 18.8V '11' = 19.2V '12' = 19.5V '13' = 19.8V '14' = 20.0V '15' = 20.5V *new in version 2.00
41	('1')	1	22kHz Tone ON/OFF

			'0' = OFF '1' = ON
42	('XXXX')	4	Not Used
46	?	1	Checksum
47	03	1	ETX

If the unit does not have dual paths, then the Path 2 settings are all X's. Changing the settings in this message for the currently selected path, is the same as changing them in the normal 'K' configuration message.

**Instruction 22 (DC Output Limits):**

Message Byte No.	Set Value / (example)	Length (bytes)	Description
1	02	1	STX
2	?	1	No of bytes in message
3	?	1	Address
4	21	1	Message instruction
5	('L')	1	'L' = DC Output Limits
6	('0')	1	Lower Limit '0' = 0 Volts '1' = -5 Volts '2' = -10 Volts
7	('0')	1	Lower Limit '0' = 0 Volts '1' = +5 Volts '2' = +10 Volts
8	?	1	Checksum
9	03	1	ETX

**Instruction 22 (Extended Ku Band Attenuation Reconfiguration Request Reply):**

Message Byte No.	Set Value / (example)	Length (bytes)	Description
1	02	1	STX
2	?	1	No of bytes in message
3	?	1	Address
4	22	1	Message instruction
5	'X'	1	Extended Message
6	'1'	1	Sub-extended message. Ku Band attenuation setting message
7	(' +123' = 12.3 dB 'MAX!' = Maximum dB)	4	Ku Band attenuation in 0.1dB steps Or 'MAX!' if the attenuator has been set to maximum level
11	?	1	Checksum
12	03	1	ETX

**Instruction 24 (Set Remote/Local Mode):**

Message Byte No.	Set Value / (example)	Length (bytes)	Description
1	02	1	STX
2	?	1	No of bytes in message
3	?	1	Address
4	24	1	Message instruction
5	('R')	1	'R' = Remote Mode 'L' = Local Mode
6	?	1	Checksum
7	03	1	ETX

The unit MUST be in remote mode to allow reconfiguration of parameters via the remote control.

**Alarm Log message routines & Remote Interrogation of the Alarms log.**

The unit will remember the number of new LOG entries that have been added since the user last requested LOG entry status.

If instruction 30 is sent, it will respond with the number of new LOG items since the last request.

Instruction 36 can be sent to get the list of currently unread LOG items, when there are no more unread LOG items the unit will respond with \*!END!\*.

Alternatively, the user can ask for LOG item [n] using instruction 32.

**Instruction 30 (Alarm Log Entry Status Request):**

Message Byte No.	Set Value / (example)	Length (bytes)	Description
1	02	1	STX
2	?	1	No of bytes in message
3	?	1	Address
4	30	1	Message instruction
5	?	1	Checksum
6	03	1	ETX

**Instruction 31 (Alarm Log Entry Status Response):**

Message Byte No.	Set Value / (example)	Length (bytes)	Description
1	02	1	STX
2	?	1	No of bytes in message
3	?	1	Address
4	31	1	Message instruction
5	('010')	3	No. of Log entries
8	('001')	3	No of Log entries that are NEW since the last Log Entry Status Request.
11	?	1	Checksum
12	03	1	ETX

**Instruction 32 (Alarm Log Entry Request):**

Message Byte No.	Set Value / (example)	Length (bytes)	Description
1	02	1	STX
2	?	1	No of bytes in message
3	?	1	Address
4	32	1	Message instruction
5	('002' = ask for log entry 2)	3	No. of the LOG entry to be returned
8	?	1	Checksum

9	03	1	ETX
---	----	---	-----

**Instruction 33 (Alarm Log Entry Response):**

Message Byte No.	Set Value / (example)	Length (bytes)	Description
1	02	1	STX
2	?	1	No of bytes in message
3	?	1	Address
4	33	1	Message instruction
5	("LOG Entry 001 of 124*Unit: +36V Fault*31.6V*23/12/04 12:23:45*")	?	Details of the LOG message Should be the same as what is displayed on screen, each line is ended with a *. LOG entry number x of n* Unit: Fault type* Extra Fault details* Date and Time*
?	?	1	Checksum
?	03	1	ETX

**Instruction 34 (Clear Alarm Log Request):**

Message Byte No.	Set Value / (example)	Length (bytes)	Description
1	02	1	STX
2	?	1	No of bytes in message
3	?	1	Address
4	34	1	Message instruction
5	?	1	Checksum
6	03	1	ETX

**Instruction 36 (Next Unread Alarm Log Item Request):**

Message Byte No.	Set Value / (example)	Length (bytes)	Description
1	02	1	STX
2	?	1	No of bytes in message
3	?	1	Address
4	36	1	Message instruction
5	?	1	Checksum
6	03	1	ETX

**Instruction 37 (Next Unread Alarm Log Item Response):**

Message Byte No.	Set Value / (example)	Length (bytes)	Description
1	02	1	STX
2	?	1	No of bytes in message
3	?	1	Address
4	37	1	Message instruction
5	("LOG Entry 001 of 124*Unit: +36V Fault*31.6V*23/12/04 12:23:45*")	?	Details of the NEXT previously unread LOG message. Should be the same as what is displayed on screen, each line is ended with a *. LOG entry number x of n* Unit: Fault type* Extra Fault details* Date and Time* If no more unread LOG message the text sent back is "!END*"
?	?	1	Checksum
?	03	1	ETX

**Instruction 40 (Unit Status Request):**

Message Byte No.	Set Value / (example)	Length (bytes)	Description
1	02	1	STX
2	?	1	No of bytes in message
3	?	1	Address
4	40	1	Message instruction
5	?	1	Checksum
7	03	1	ETX

**Instruction 41 (Unit Status Request Reply):**

Message Byte No.	Set Value / (example)	Length (bytes)	Description
1	02	1	STX
2	?	1	No of bytes in message
3	?	1	Address
4	41	1	Message instruction
5	(' PTR50')	27	Type of unit this is: P7000, P7001 etc
32	('01234' = Serial No 01234)	5	Serial Number
37	('0112.34')	7	Software Version Number
44	('0' = OK)	1	Summary Alarm OK/FAULT '0' = OK '1' = FAULT
45	('0')	1	+5V voltage out of range fault '0' = OK '1' = FAULT
46	('0')	1	+15V voltage out of range fault '0' = OK '1' = FAULT
47	('0')	1	-15V voltage out of range fault '0' = OK '1' = FAULT
48	('0')	1	Primary voltage out of range fault '0' = OK '1' = FAULT
49	('0')	1	Temperature out of range fault '0' = OK '1' = FAULT
50	('0')	1	Humidity out of range fault '0' = OK '1' = FAULT
51	('0')	1	External Reference fault '0' = OK '1' = FAULT
52	('0')	1	100MHz fault '0' = OK '1' = FAULT
53	('0')	1	Coax Switch fault '0' = OK '1' = FAULT
54	('0')	1	Internal ethernet module fault '0' = OK '1' = FAULT
55	('23/12/02 12:34:56')	17	OK Since time/date string, if there is a fault with this down/up part of the converter then the string is blank.
72	('0')	1	1:1 Status '0' = Offline '1' = Online
73	('0')	1	Remote mode '0' = Local '1' = Remote
74	('0')	1	External Reference '0' = Off '1' = On
75	?	1	Checksum
76	03	1	ETX

**Instruction 45 (Redundancy Status Request):**

Message Byte No.	Set Value / (example)	Length (bytes)	Description
1	02	1	STX
2	?	1	No of bytes in message
3	?	1	Address
4	45	1	Message instruction
5	?	1	Checksum
7	03	1	ETX

**Instruction 46 (Redundancy Status Request Reply):**

Message Byte No.	Set Value / (example)	Length (bytes)	Description
1	02	1	STX
2	?	1	No of bytes in message
3	?	1	Address
4	46	1	Message instruction
5	('1')	1	Redundancy Type Configuration '1' = 1 for 1
6	('M')	1	Redundancy Manual Mode 'M' = Manual 'A' = Auto
7	('0')	1	Online Status '0' = Offline '1' = Online
8	('A')	1	Unit Identifier 'A' or 'B'
9	('X')	1	NOT USED
10	('A')	1	Unit Online 'A' or 'B' when in 1 for 1 configuration. 'A' or 'B' or 'S' when in 1 for 2 configurations and the unit selected as standby otherwise 'X' '@' means no redundant controller attached, unit online not known.
11	('1')	1	Coax Switch Position '1' or '2' '0' means no redundant controller attached, position not known Used for 1 for 1, 1 for 2 configurations, irrelevant in 1 for N configuration.
12	('00')	2	NOT USED
14	('1')	1	Redundancy control status '0' = Normal operation '1' = Under redundancy control
15	?	1	Checksum

**Instruction 47 (Redundancy Change Request):**

The 'unit to go online' parameter can only be modified when it is being changed on the currently offline unit.

Message Byte No.	Set Value / (example)	Length (bytes)	Description
1	02	1	STX
2	?	1	No of bytes in message
3	?	1	Address
4	47	1	Message instruction
5	('M')	1	Redundancy Mode 'M' = Manual 'A' = Auto
6	('S')	1	Unit to go Online 'A' or 'B' when in 1 for 1 configuration
7	?	1	Checksum
8	03	1	ETX

### 5.3 Ethernet remote control (Optional)

The Ethernet option for the PTR50 series products adds the ability to control the unit by Ethernet as well as by the existing standard RS232 or RS485, this is achieved via a separate module within the unit.

The unit can be controlled through the Ethernet port using three different approaches.

#### TCP Port

The unit can be controlled using the serial remote-control messages as described earlier sent through the TCP port set in the Ethernet menu option.

#### Web Page

The unit can be controlled via the in-built web server's web page. There are two pages, Status and Configure. Hopefully both of which are self-explanatory. Figures 13 & 14 show sample screen shots of the web pages (these may not be representative of the model in this manual).



Figure 13

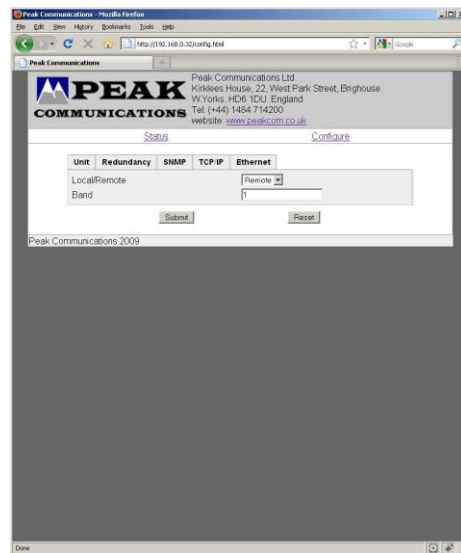

Figure 14

#### SNMP

Units fitted with Ethernet, have a built-in SNMP (Simple Network Management Protocol) agent software.

It supports SNMP Trap, RFC1155, 1157, 1212, 1213, 1901 & 1906, as well as the Peak MIBS.

The Peak SNMPv2 MIB files are supplied by Peak Communications Ltd, below is a quick overview of them.

The Peak Enterprises node is essentially split into three main areas:

**Converters** - In this node there is a peakxxxxxxxxxxxxxxxxModule showing a table of the Converter module(s), this is where the band of the unit can be checked/changed.



*Unit* – This node allows the unit status to be checked as well as the Ethernet and redundancy settings.

*PeakFaultsModule* – This node contains the unit summary alarm as well as a table showing all the faults currently on the unit.

## APPENDIX 1 Terms and conditions of sale

### Peak Communications Ltd

#### Terms and Conditions of Sale

##### 1 Application of Terms and Conditions

The following terms and conditions shall constitute the entire agreement between Peak Communications Limited ("the Seller") and the purchaser of any goods or services ("the Customer) from the Seller. No contract shall be formed between the Seller and the Customer until the dispatch by the Seller to the Customer of the Seller's written acknowledgment of order. Unless otherwise expressly agreed in writing by the Seller, these conditions shall apply to all quotations and invoices given, orders received and accepted and contracts undertaken by the Seller. All prices quoted by the Seller are based upon these Conditions of Sale and reflect the limitations upon the Seller's liability which they contain. No modifications of these terms and conditions shall have effect unless agreed in writing by the Seller and shall not be affected by any documentation or communication from the Customer purporting to give effect to different terms and/or conditions.

##### 2 Invoicing and Payment Terms

a) Unless otherwise expressly agreed in writing between the Customer and the Seller, the Seller shall be entitled to invoice the Customer for the price of goods on delivery of the goods, unless the goods are to be collected by the Customer (or their agent) or the Customer wrongfully fails to take delivery of the goods, in which event the Seller shall be entitled to invoice the Customer for the price at any time after the Seller has notified the Customer that the goods are ready for collection or (as the case may be) the Seller has tendered delivery of the goods.

b) Charges for services will be invoiced on completion of the services.

c) Where credit terms are allowed by the Seller to the Customer, the terms of payment of all invoices issued by the Seller to the Customer are, unless otherwise decreed in writing, to be paid net at the Seller's registered office within 30 days from the date of the invoice unless otherwise stated on the invoice and subject to condition (d) below. Where credit terms are not given by the Seller, a pro-forma invoice will be issued by the Seller and goods will be dispatched on payment.

d) Notwithstanding condition ©, the Seller shall without prejudice to its other rights, have the right by notice in writing to the Customer to demand immediate payment of all monies due from the Customer to the Seller for goods delivered at whatever time. The Seller also reserves the right to ask for a payment of a deposit before acceptance of an order.

e) The Seller reserves the right to charge interest on all or any sums not paid within 30 days from the date of invoice at the rate of 2% of the total invoiced amount for every period of 30 days (and pro rata for any part of a period of 30 days whether before or after judgment) from the due date of payment until the date of actual receipt of payment in full by the Seller.

f) The Customer shall indemnify the Seller against any loss or expense sustained or incurred by the Seller as a result of any change in currency exchange rates or in exchange control or other governmental regulations by reason of or in connection with any failure on the part of the Customer to pay any sum payable hereunder within 30 days of the date of the invoice,

g) The Seller shall have the right to invoice the Customer for part delivery or provision of goods or services to the Customer notwithstanding the fact that other goods or services are to be delivered or provided to the Customer under the contract.

h) The Seller's rights under this paragraph (2) shall be exercisable in addition to all and any other rights the Seller may have under these Terms and Conditions of Sale.

i) All sums owing to the Seller to the Customer shall be paid in full without any objection, set off or counterclaim, save in respect of mutual debts and set off which cannot be excluded by reason of statute

##### 3 Prices

a) The price of goods shall be the price ruling at the date of delivery unless otherwise stated on the quotation invoice, or previously agreed in writing by the seller. The prices are based on the costs of packing, documentation, insurance and any other costs incurred by the Seller, prior to dispatch from the Sellers works, but excludes all customs duties levies and freight charges.

b) All prices quoted in writing or by fax by the Seller to the Customer shall have a validity of 30 days unless otherwise expressly stated on the specific quotation. Thereafter the price must be revalidated in writing or by fax by the Seller to the Customer at the Customer's request.

c) The Seller reserves the right to alter its prices, its published terms of trade and its catalogue and other published material at any time and without prior notice.

d) The Seller reserves the right to alter its quoted prices during the course of a contract for the supply of goods or services in that contract to reflect changes in;

(i) VAT, Duty and other levies brought about by changes in governmental legislation.

(ii) Costs brought about by exchange rate fluctuations or changes in manufacturers' list price.

#### 4 Specification

a) Goods are manufactured to the specifications as published within the Sellers documentation. Particular specifications not mentioned in the documentation will be quoted prior to order acceptance at the request of the Customer. Any specifications not agreed at acceptance of order will not form part of any contract or warranty claim.

b) If the goods are to be manufactured or any process is to be applied to the goods by the Seller in accordance with a specification submitted by the Customer, the Customer shall indemnify the Seller against all loss, damages, costs and expenses arising out of or in connection with or paid or agreed to be paid by the Seller in settlement of any claim or infringement of any patent, copyright, design, trade mark or other industrial or intellectual property rights of any other person which results from the Seller's use of the Customer's specification.

c) The Customer shall be responsible for stipulating the specifications of goods to be supplied by the Seller and the Seller accepts no responsibility where the Customer has incorrectly stipulated required specifications, where the specification stipulated is not suitable for the Customer's actual requirements. The Seller will however on request provide advice in relation to the suitability of different specifications of goods for the purposes identified by the Customer, although any such advice is provided for guidance only and the Customer accepts ultimate responsibility for the suitability for the Customer's actual requirements on the specification of the goods stipulated by the Customer. The Customer shall also have responsibility for ensuring that the capacity and performance of the goods are specified in its order and are sufficient and suitable for its purpose

d) The Seller reserves the right to make any changes in the specification of the goods which are required to conform with any applicable statutory or EC regulatory requirements or, where the goods are to be supplied to the Seller's specification, which do not materially affect their quality or performance.

e) The Seller reserves the right, if extra expense or nay increase in costs or overheads are incurred by the Seller as a result of modifications made at the Customer's request, the Customer's special requirements or instructions, or the failure of the Customer to supply drawings, plans, specifications or any other information whatsoever to enable to the Seller to proceed with the Contract, to increase the price by giving notice in writing of the amount of such increase to the Customer

f) Goods are manufactured and dispatched to comply with Customer's Order as interpreted by the Seller. Any costs for changes arising, due to interpretation of the order, are at the Customers expense.

g) At the time of acceptance of the specification submitted by the Customer the Seller will give an estimate of the risk involved in achieving the Customer Specification. If any deviation from the customers Specification is found during development and manufacture, the Customer will be informed within 7 days.

#### 5 Title and Risk

a) Risk in the goods shall pass to the Customer when delivery is made to the customer or its agents, subcontractors or carriers except that, where the goods are to be delivered at the Seller's premises, risk in the goods shall pass at the time when the Seller notifies the Customer that the goods are ready for collection.

b) All the goods shall remain the sole and absolute property of the Seller until such a time as the Customer shall have paid to the Seller the agreed price together with the full price of any other goods the subject of any other contract with the Seller.

c) The Customer acknowledges that the Customer is in possession of goods solely as bailee for the Seller until such time as the full price thereof is paid to the Seller together with the full price of any other goods the subject of any other contract with the Seller.

d) The Customer's right to possession of the goods shall cease if-

(i) The Seller serves notice requiring that the goods be returned; or

(ii) In the case of an individual, he commits an available act of bankruptcy or proposes to enter into a voluntary arrangement with his creditors; or

(iii) In the case of a company:-

It is unable to pay its debtors for the purposes of S 123 of the Insolvency Act 1986; or a Receiver or Administrative Receiver is appointed; or a Petition for an Administration Order is presented or an Administrator appointed; or

The Customer proposes an informal arrangement with its creditors or a formal corporate voluntary arrangement; or

The Customer takes any step to enter into a voluntary liquidation, or if a Liquidator is appointed, or if a Petition for the winding up of the Customer is presented; or In the event that the Customer is not a

company incorporated in England, any event analogous to those specified above shall occur in relation to the Customer. Until such time as the Customer becomes the owner of the goods, the Customer will store them on his premises separately from the Customer's own goods or those of any other person and in a manner which makes them readily identifiable as the goods of the Seller.

e) If any of the events listed at d(ii) and (iii) above occur in relation to the Customer (or any parent of the Customer), or in the event that the Customer is not a company incorporated in England, any events analogous to those specified in d(ii) or (iii) occur, and then and in any such events or such events or sums due or becoming due by the Customer to the Seller shall forthwith and without notice immediately become due and payable in full. In addition, the Seller shall have the right at its discretion to decline to perform any contract in whole or in part then not performed by the Seller in whole or in part without prejudice to all and any of the rights it may have under the terms and conditions of sale.

#### 6 Cancellation of Order

a) If the Customer shall fail to pay to the Seller on the due date any sum payable hereunder or shall exceed its credit limit or breach the terms upon which such credit has been offered or shall suffer any of the events listed in Condition 5d)(ii) (being an individual) or 5d)(iii) (being a company) the Seller may, without prejudice to its other rights, and without prejudice to the generality of Condition 2(d) demand immediate payment by the Customer of all unpaid accounts and, in addition, and suspend or cancel further deliveries and cancel this and any other contract between the Seller and the Customer without any liability attaching to the Seller in respect of such suspension or cancellation and debit the Customer with any loss sustained thereby.

b) The Seller will only accept a cancellation or postponement of any order by or on behalf of the Customer or any refusal to accept delivery if the Customer pays the amount specified by the Seller as representing its losses incurred thereby. Without prejudice to the generality of the foregoing the Seller will not accept cancellations of, and the Customer will be obliged at all times to purchase, materials which have already been manufactured or which have been modified or specifically purchased to meet the Customer's requirements. Any amount owing by the Seller to the Customer as a result of any properly cancelled order will be satisfied by the Seller issuing credit notes to the Customer to a value equal to the amount owing.

#### 7 Insurance of Goods in Transit

a) The Seller will insure the goods for a total invoice price to the Customer if transport is agreement to be effected by the Seller or its agent. Where the Seller insures goods the liability of the Seller shall be absolutely limited to the amount if any received by the Seller under such insurance from its insurers from which a reasonable deduction may be made for administrative expenses.

b) If the Customer arranges transport either directly or indirectly through its agents the Customer must insure the goods against loss or damage on any account whatsoever.

c) The Seller shall not in any event be liable for any loss or damage to the goods whilst in transit or where the goods are transported by an outside freight carrier.

#### 8 Delivery

a) Any time or date for the dispatch or delivery of goods for the completion of work whether specified in the Seller's quotation or otherwise given by the Seller shall be taken as an estimate made by the Seller in good faith but shall not be binding upon the Seller either as a term of the contract or otherwise. In no circumstances shall the Seller be liable for any loss or damage sustained by the Customer in consequence of failure to deliver within such time or by such date or in consequence of any other delay in delivery however caused.

b) Unless otherwise agreed in writing delivery shall be made in the case of sales within the United Kingdom at the premises specified by the Customer and, in the case of export sales, at the United Kingdom port of shipment specified by the Customer. Subject to Condition e) below the risk in the goods shall pass to the Customer upon delivery or, in the case of export sales, upon the goods leaving the Seller's premises.

c) The Seller may deliver the goods in instalments and invoice the Customer as if each instalment comprised a separate contract upon the terms of these Conditions of Sale.

d) The Seller does not accept any responsibility for failure to deliver or a delay in delivery where such failure or delay is caused by other suppliers or contractors upon whom the Seller is reliant to ensure a timely delivery.

e) If delivery of the goods is delayed or prevented by any act or omission of the Customer, the Seller may put the goods into storage at the Customer's risk and expense. Any redeliveries will be at an extra cost as specified by the Seller, and the Customer will indemnify the Seller in relation to any losses, claims, expenses or liabilities which the Seller suffers or incurs as a result of such delay or prevention (including in particular but without limitation liabilities to any third party suppliers).

#### 9 Acceptance

a) Acceptance of delivery of the equipment by the Customer or its agent shall be conclusive evidence that the equipment was delivered in good operating condition and in all respects in accordance with the contract under which it was supplied and that it was fit for any purpose for which it may be required by the Customer.

b) Shortage claims or claims that goods are defective or otherwise not in accordance with the contract, will only be considered if the Seller receives written notification thereof within seven days of delivery failing which no liability will be accepted.

#### 10 Warranty

a) Subject to the conditions set out below the Seller warrants that the goods will correspond with their specification at the time of delivery and will be free from defects in material and workmanship:

b) The Seller shall be under no liability in respect of any defect in the goods arising from any drawing, design or specification supplied by the Customer.

c) The Seller shall be under no liability in respect of any defect arising from fair wear and tear, willful damage, negligence, abnormal working conditions, failure to follow the Seller's instructions (whether oral or in writing), misuse or alteration or repair of the goods without the Seller's approval,

d) Notwithstanding the terms of sub-clauses (a) and (b) above, the Seller's liability in respect of all goods supplied by it but manufactured by third parties shall be limited to such warranty as shall be provided by the manufacturer to the Seller and the Seller shall have no further or larger responsibility whatsoever.

e) Where goods are returned by the Customer to the Seller or the Seller's agent for warranty or other repair or calibration the Customer shall be responsible for all costs (including freight, duties and insurance) of delivering the goods to the Seller or the Seller's agent and/or at the Seller's option the manufacturer and the return of the goods thereafter to the Customer.

f) All goods returned must have full documentation as to the reason for the return. The Seller reserves the right to charge for time checking equipment which has no faults.

g) All other warranties or representations in respect of the goods expressed or implied by or under statute or custom or trade usage are hereby expressly excluded.

h) The Seller's entire liability in respect of any claim for loss or damage arising from the supply of goods or services (including the proper use of goods by the Customer) shall be limited to sum's recovered under the Seller's liability insurance. Without prejudice to the foregoing, the Seller shall not be liable for any consequential loss or damage (including, without limitation, loss of profits and goodwill).

#### 11 Provision of Services

a) Where the Seller provides personnel to the Customer, the Customer shall not, without the prior written consent of the Seller use such personnel to undertake any work which, in the Seller's opinion, is inappropriate to their qualifications and experience, or which is not directly connected with the services. If services are to be provided for an indeterminate period, then they will continue until terminated by either party giving to the other (thirty days') prior written notice.

b) The Customer shall be deemed to have been granted a licence to use any program or material supplied by the Seller in performing services for the period during which the services are performed only. This licence shall not entitle the Customer to grant any sub-licence or to provide these programs or materials for use or copying by any third party.

c) The Seller warrants that all services will be performed with reasonable skill and care. The Seller will not be liable for breach of this warranty unless the Customer reports the breach to the Seller within 1 month of completion of the services.

d) The Customer agrees that during a period of 6 months after completion or termination of any service provided by the Seller, it will not solicit the employment or services of any employee of the Seller who has been working in connection with the provision of services to the Customer

#### 12 Lien

The Seller shall have a general lien in respect of all sums due from the Customer upon all goods to be supplied to such Customer or upon which work has been done on the Customer's behalf and, upon 14 days' written notice to the Customer, may sell such goods and apply the proceeds towards the satisfaction of the sums due to the Seller.

#### 13 Force Majeure

The Seller shall not be liable for any delay or failure in the performance of any of its obligation hereunder if the delay or failure is due to causes outside its reasonable control and the Seller shall have the right at its option (a) to suspend further performance of the Contract until such time as the cause of the delay shall be no longer present; or (b) to be discharged from further performance of liability under the Contract and if the Seller exercises such right, the Customer shall thereupon pay the Contract Price less a reasonable allowance for what has not been performed by the Seller.

#### 14 Descriptive Leaflets, Catalogues and Illustrations

All descriptive leaflets, catalogues, illustrations, specifications, drawings and other particulars issued by the Seller are approximate only and shall not form part of any contract between the Seller and the Customer unless specifically stated in writing by the Seller.

#### 15 Representation by Seller's Employees

The Seller's employees or agents are not authorised to make any representations concerning the goods or services provided under the contract unless confirmed by the Seller in writing. In entering into the contract the Customer acknowledges that it does not rely on any such representations which are not so confirmed.

#### 16 Copyright

Copyright in all drawings, specifications, designs, descriptions and documents issued by the Seller to the Customer or other third parties shall be and remain the property of the Seller and no copies shall be taken without the prior written consent of the Seller.

#### 17 Licence Grant

The Seller hereby grants to the Customer a non-exclusive, non-transferable licence to use any programs supplied by the Seller for internal purposes only for the duration of the services provided by the Seller and on the equipment identified by the Seller. Any other use is prohibited. Such programs may not be used to provide a service to a third party without the prior written agreement of the Seller and subject to such extended use charges as the Seller may require.

#### 18 Severance

a) While the restrictions and exclusions of the Customer's rights whether express or implied by common law, statute, custom of the trade, course of dealing or otherwise, are considered to be fair and reasonable having regard to the circumstances known to and in the contemplation of the parties at the date hereof, it is recognised that certain of the restrictions and exclusions may become unfair and unreasonable due to unforeseen circumstances and accordingly it is hereby agreed that if any of such restrictions and exclusions shall be adjudged to be void but would be valid if part of the wording thereof were deleted the said restriction or exclusion shall apply with such modifications as may be necessary to make it valid and effective.

b) If any condition herein shall be deemed void for any reason whatsoever, but would be valid if part of the wording thereof were deleted the said condition shall apply with such modifications as may be necessary to make it valid and effective.

#### 19 General

a) Any notice required or permitted to be given by either party to the other under these Terms and Conditions of Sale shall be in writing addressed to that other party at its registered office or principal place of business or such other address as may at the relevant time have been notified pursuant to this provision to the party giving the notice.

b) No waiver by the Seller of any breach of the contract by the Customer shall be considered as a waiver of any subsequent breach of the same or any other provision.

c) If any of the provisions of these Terms and Conditions of Sale is held by any competent authority to be invalid or unenforceable in whole or in part the validity of the other provisions of these Terms and Conditions of Sale and the remainder of the provision in question shall not be affected.

d) These Terms and Conditions of Sale shall be governed and construed in all respects in accordance with the Laws of England. The Customer hereby submits to the non-exclusive jurisdiction of the English Courts in relation to these Terms and Conditions of Sale and all matters falling to be determined hereunder or in connection herewith.